

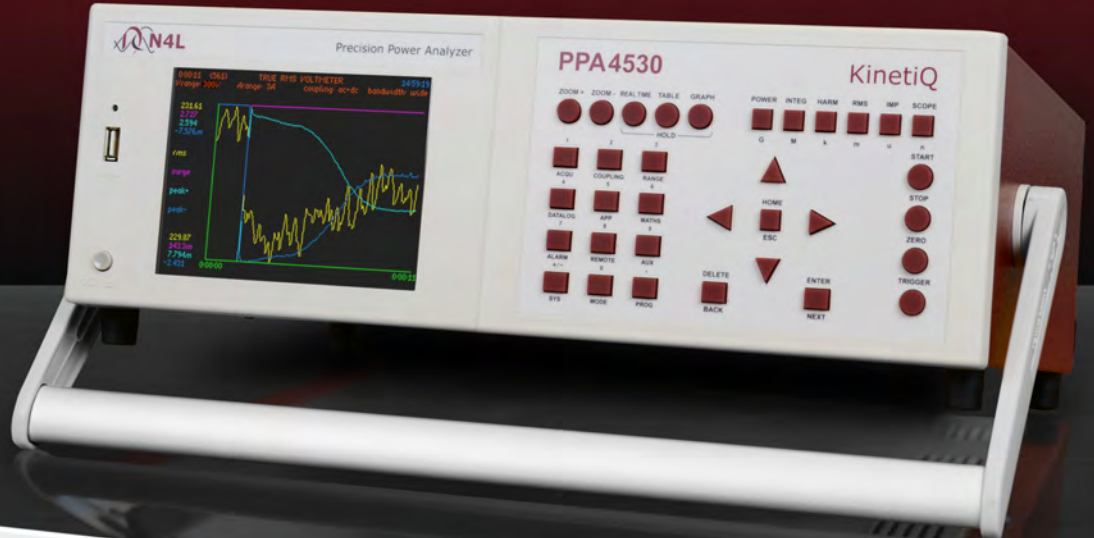

Precision Power Analyzers

PPA4500 Series PPA5500 Series



Leading wideband accuracy	Basic 0.01%(PPA5500) with class leading high frequency performance
Wide frequency range	DC, 10mHz to 2MHz
Fast sample rate and No-Gap	2.2M samples/s
Leading phase accuracy	0.005 Degrees plus 0.01 degrees per kHz
Built in high precision current shunt	10Arms, 30Arms or 50Arms with up to 1000Apk direct plus a wide range of external sensors
Versatile interfaces	RS232, USB, LAN, GPIB as standard (PPA5500) plus direct torque and speed
Range of PC software options	Remote control, monitoring and recording of real time data, tables and graphs
PWM Motor Drive Measurements	Highest performance Analyzer on the market for PWM Motor Drive Evaluation
External Voltage BNC Connector	Unique External BNC connector with high sensitivity to interface with external High Voltage Probes

PPA5530 Precision Power Analyzer

FRONT VIEW

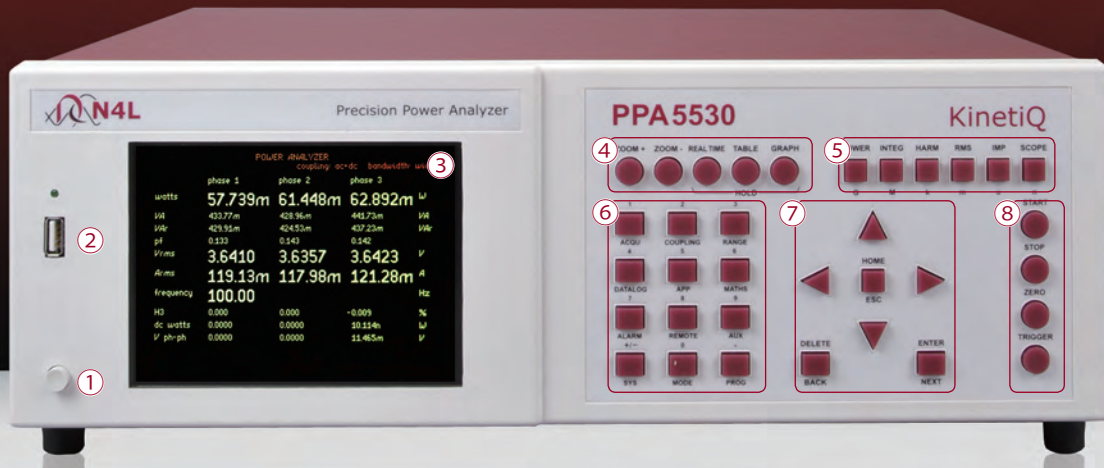

① POWER BUTTON

② FRONT USB PORT

USB memory port allows data or screendumps to be saved directly to a USB pen drive

③ DISPLAY SCREEN

White LED backlight colour TFT display with high contrast and wide viewing angle

④ SCREEN DISPLAY OPTIONS

Zoom, Real time, Table and Graph options

⑤ MEASUREMENT FUNCTION SELECTION BUTTONS

- POWER ANALYZER
- POWER INTEGRATOR
- HARMONIC ANALYZER
- TRUE RMS VOLTMETER and AMMETER
- IMPEDANCE METER
- OSCILLOSCOPE



Measurement Mode Control

⑥ MEASUREMENT SETTINGS BUTTONS

Acquisition settings - Sets wiring configuration, Smoothing and data logging

Coupling - Set coupling to AC, DC or AC+DC, also set bandwidth

Range - Internal or external attenuator, autoranging settings, scale factors

Application mode - PWM, ballast, inrush current, power transformer, standby power, IEC61000 (PPA5500)

Plus direct configuration of - Alarm, Auxiliary, Remote, System and Program functions

⑦ MENU SELECTION AND CURSOR CONTROL

⑧ START, STOP, ZERO AND TRIGGER

Trigger button refreshes measurement, Zero resets datalog or allows an offset trim

Start and Stop buttons provide manual control of a measurement period

REAR VIEW



PPA45/5530 (3 Phase)

⑨ PHASE INPUTS

Direct voltage Input: 3kVpk (1kVrms) in 9 ranges*

Direct current Input: 300Apk (30Arms) Standard Model, 30Apk (10Arms) Low Current Model, 1000Apk (50Arms) High Current Model

External voltage and current sensor inputs to 3Vpk in 9 ranges* - BNC Connector

⑩ SYNC CONNECTOR

All PPA models can offer up to 12 phase analysis using the PPA LoG PC program. Additionally two PPA45/5530's can be connected via the extension port and sync BNC connector to form a 6 phase analyzer when a PC is not available.

⑪ EXTERNAL SENSOR INPUTS

+/-10V or pulsed input from torque and speed sensors provides direct measurement of mechanical power + analogue output

⑫ PC INTERFACE CONNECTIONS

Standard interfaces RS232 + USB + LAN + GPIB (Standard on PPA5500, LAN + GPIB optional on PPA4500)

⑬ LOW NOISE COOLING FANS

Air bearing low noise fans are utilized to ensure minimum audible and electrical noise while maintaining a stable operating temperature for the high precision low inductance internal current shunts.

*PPA4500 - 8 ranges



FEATURES

High Speed Power Measurement - 2ms* Datalog Interval PPA5500 PPA4500

Measurements include all frequency components in power waveforms for example, fundamental, harmonics of the fundamental and the carrier of a PWM inverter output by maintaining 2.2Ms/s sampling at any drive frequency

※PPA4500 10ms datalog interval

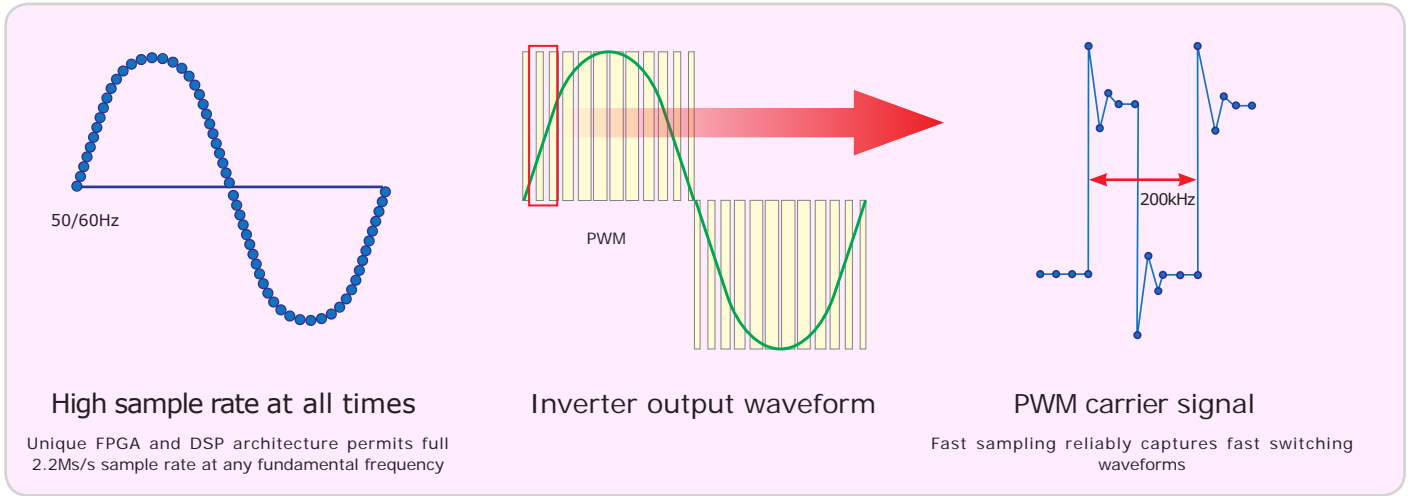

2MHz Wideband Frequency Response PPA5500 PPA4500

With 2MHz bandwidth and exceptionally flat response, the PPA provides precision analysis of total power in applications such as lighting ballasts or PWM drives that involve a wide range of frequency components. Proprietary to N4L, a digital process called Expanded Nyquist Sampling ensures no alias components

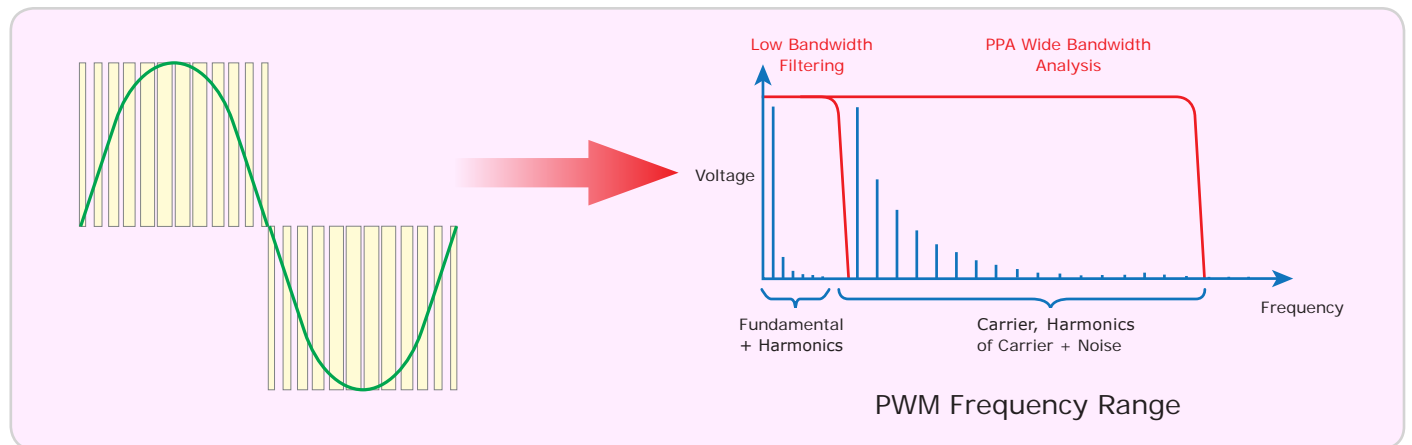

High Accuracy PPA5500 PPA4500

Unique voltage and current analogue card design ensures high accuracy for both power and harmonic analysis

Class Leading Power Accuracy

PPA5500 Power Accuracy: $[0.03\% + 0.03\%/pf + (0.01\% \times kHz)/pf]$ Rdg + 0.03%VA Rng
240V (300V Range), 1A (3A Range), Power Factor : 1 (40-400Hz 0.02%VA Rng)

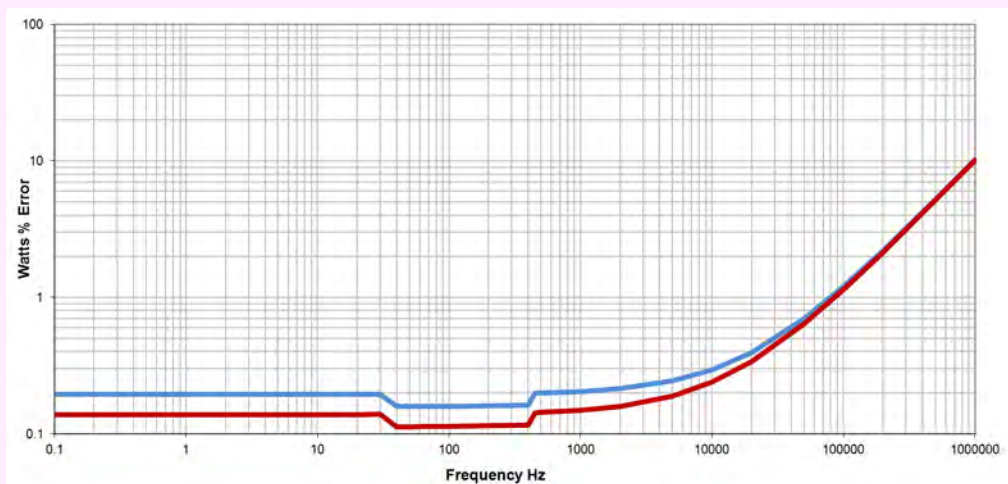

DFT Real Time No Gap Analysis PPA5500 PPA4500

Many power applications have fast changing asynchronous current pulses which are not suited to fixed data length FFT analysis. The PPA series combine a real time DFT (Discrete Fourier Transform) technique with variable window no gap analysis to ensure the optimum speed and accuracy at all times

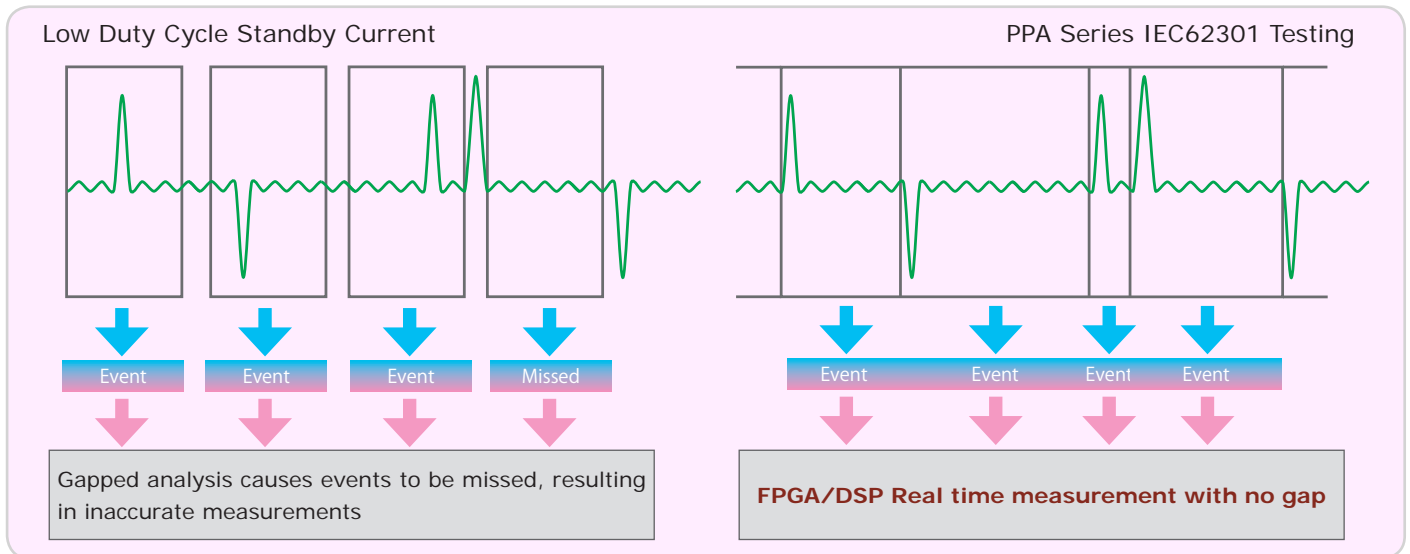

- Missing data compromises power accuracy
- Long term measurement integration achieves approximately correct average power

- Real Time No Gap analysis ensures correct power measurement
- Simultaneous fundamental and pulse frequency synchronization quickly obtains the correct power

Up to 6 Phase Analysis PPA5500 PPA4500

Master/Slave mode enables two PPA45/5530's to be fully synchronized into a single 6 phase measurement system
 ※4 or more phase measurements provided via N4L PC software or master slave mode

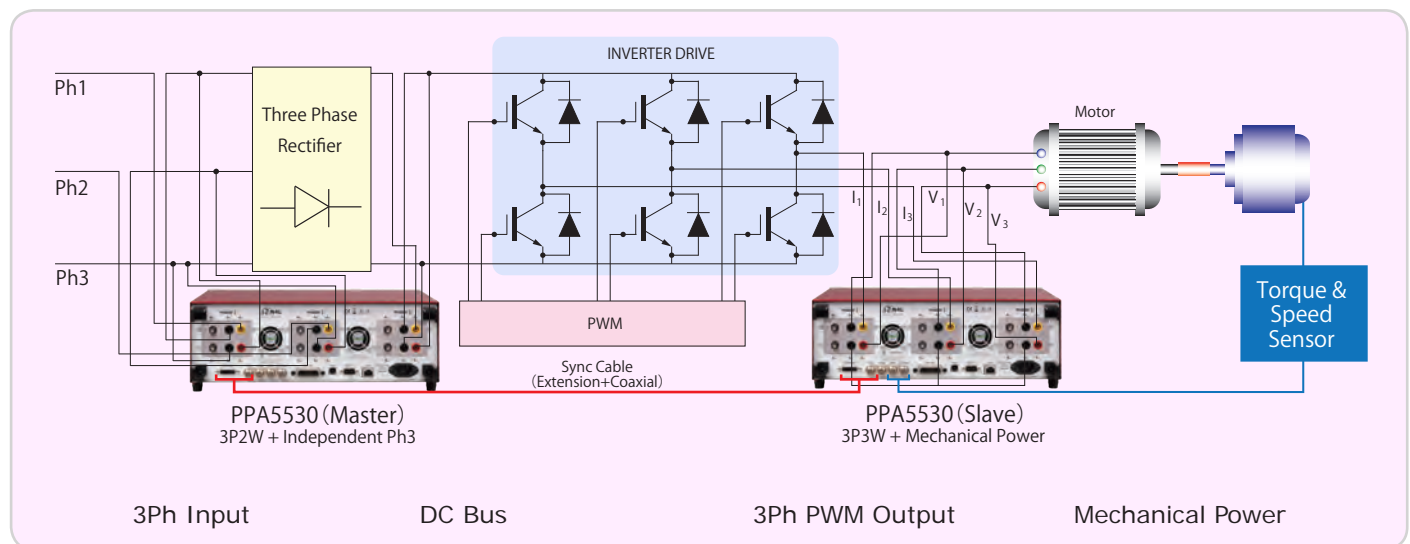

Advantages of Dual PPA vs Single instrument

- Twice the processing power as one unit
- Flexibility between different applications
- Units fully synchronized giving single point of control

Measurement parameter examples

- Input/Output power measurement
- Efficiency of the inverter
- Inverter output voltage harmonics
- Motor drive characteristics

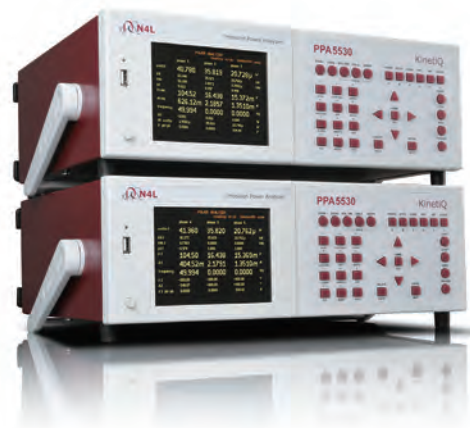

FUNCTIONS

Input Torque and Speed Sensor PPA5500 PPA4500

Direct measurement of torque and speed from dedicated inputs that are fully synchronized with the voltage and current channels permits true real time power conversion efficiency to be evaluated

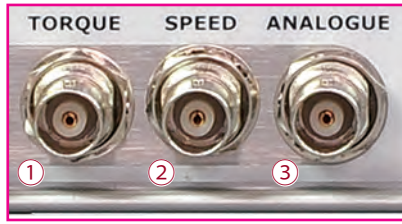

- ① TORQUE Bipolar $\pm 10V$ / pulsed
- ② SPEED Bipolar $\pm 10V$ / pulsed
- ③ ANALOGUE Analogue output of selected function $\pm 10V$

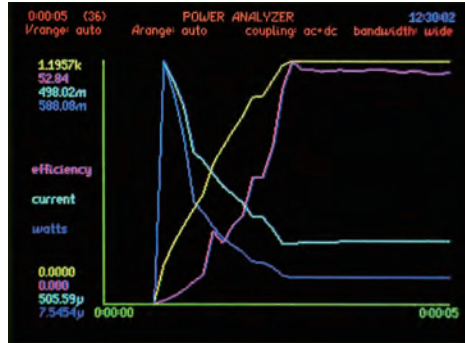

Graph

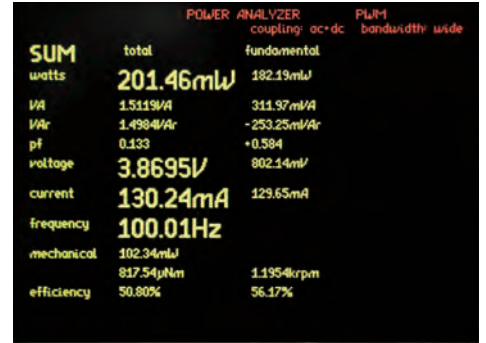

Real time data

Built in Amplifier and Unique Shunt Resistor PPA5500 PPA4500

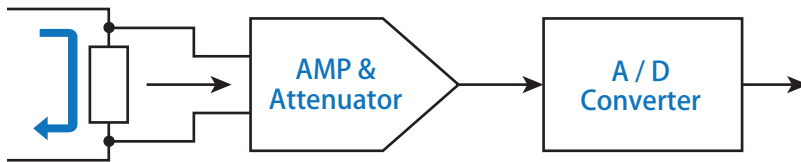

The PPA series use a single shunt resistor unique to N4L that combines exceptional linearity and no need for relay switching which can cause measurement errors

Model	Low Current Model	Standard Model	High Current Model
PPA5500	9 ranges: 3mA _{pk} - 30A _{pk} (10Arms) 100mΩ Shunt	9 ranges: 30mA _{pk} - 300A _{pk} (30Arms) 10mΩ Shunt	9 ranges: 100mA _{pk} - 1000A _{pk} (50Arms) 3 mΩ Shunt
PPA4500	8 ranges: 10mA _{pk} - 30A _{pk} (10Arms) 100mΩ Shunt	8 ranges: 100mA _{pk} - 300A _{pk} (30Arms) 10mΩ Shunt	8 ranges: 300mA _{pk} - 1000A _{pk} (30Arms) 3mΩ Shunt

External shunt options

(DC ~ 1MHz, 0.1% Accuracy, Inductance < 1nH)

Model	Maximum Current		Bandwidth
	Rated A	Peak	
HF500	500Arms	5000A _{pk}	DC ~ 1MHz
HF200	200Arms	2000A _{pk}	
HF100	100Arms	1000A _{pk}	
HF020	20Arms	200A _{pk}	
HF006	6Arms	60A _{pk}	
HF003	3Arms	30A _{pk}	



HF003



HF500



Any parameters can be enlarged with the zoom function

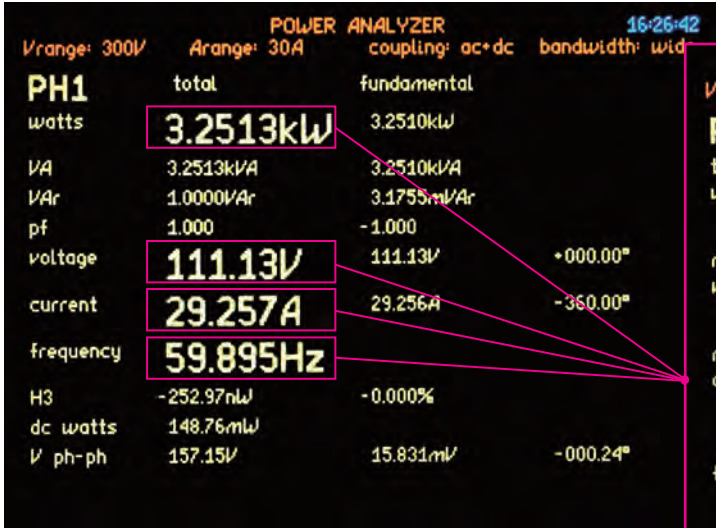

Zoom function enabled on total watts, rms voltage, rms current and frequency

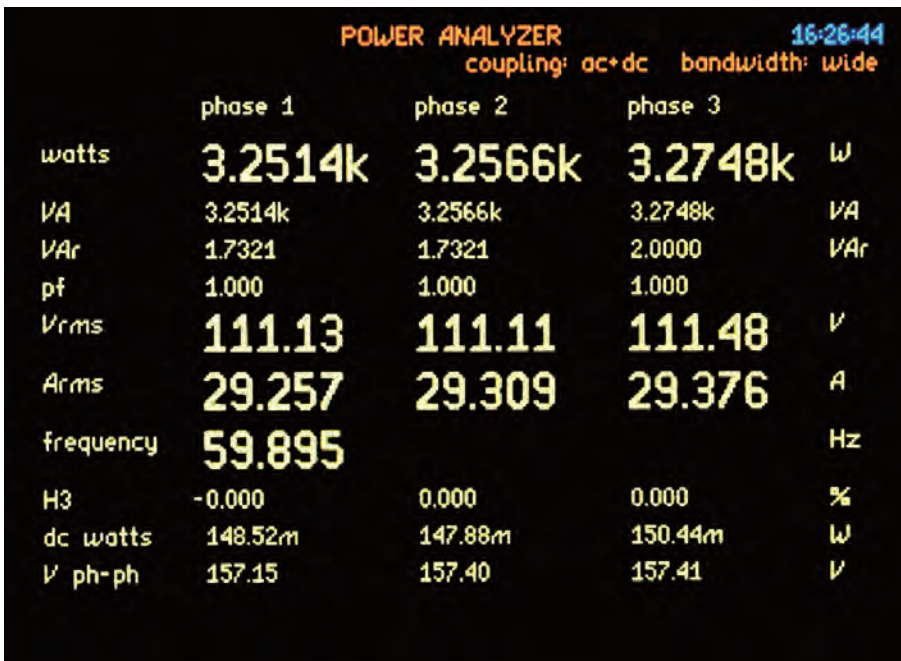

3 Phase analysis display selectable in both Total and Fundamental values

All power measurement and RMS values are computed simultaneously allowing measured values to be selected and viewed during analysis

Here, three phase total power is selected with all primary power functions in each phase plus frequency, a selected harmonic, dc watts and phase to phase voltage

Mechanical power, Maths and Efficiency functions can also be added to this screen giving real time analysis of electrical or electrical to mechanical systems

MEMORY

Large 1GB (PPA5500 series) internal memory, data logging from 2ms intervals with synchronization to the fundamental frequency and no gap between measurements

Datapoint storage up to 10M in the PPA5500 series

Alternatively the data can be stored in an external USB pen drive or directly to PPALoG PC software

Voltage, Current, Frequency and Power - Examples of graph mode

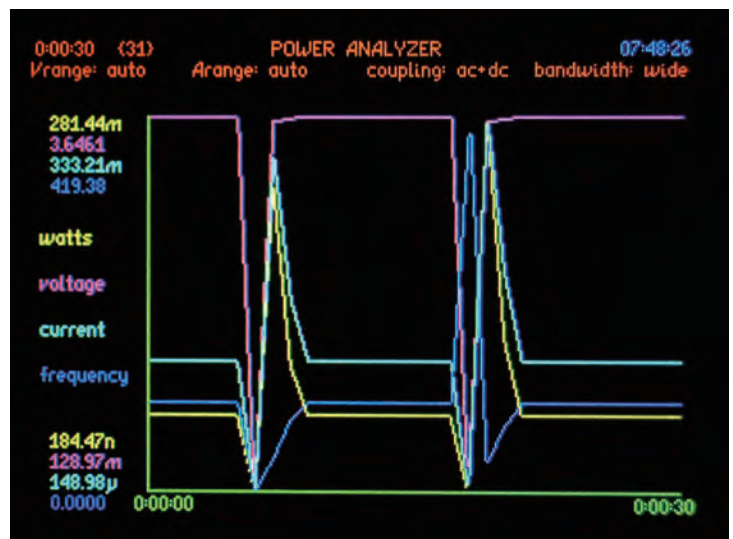

Trend analysis

MEASUREMENT MODES

Power Integrator (power consumption) Mode, RMS Meter Mode and Impedance Meter Mode



Power Integrator mode

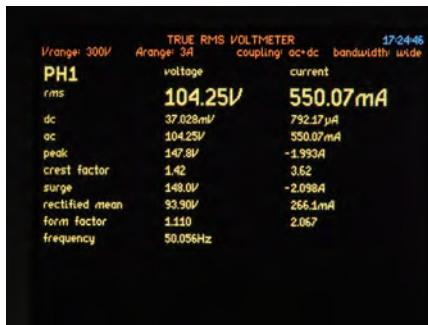

RMS Voltmeter mode



Impedance meter mode

Note

In addition to detailed measurements of the phase power parameters, you can check the balance of power between the phases and observe computed neutral current when 3 phase 4 wire connection is selected

Harmonic Analyzer and Oscilloscope

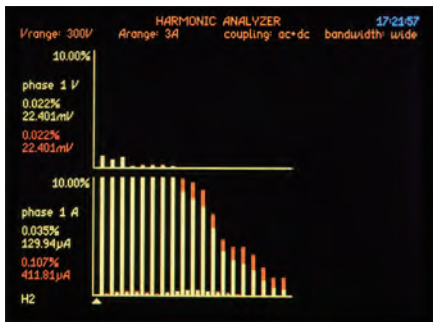

Harmonic analyzer (Bar graph)

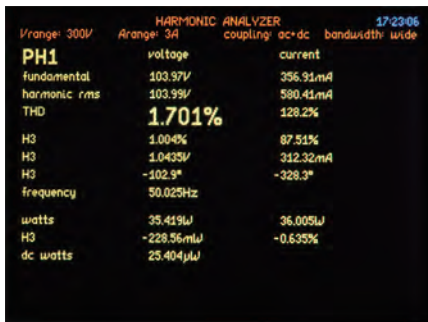

Harmonic analyzer summary page

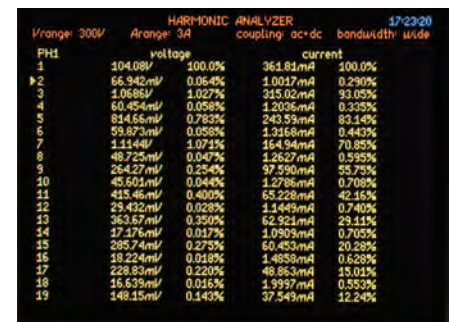

Harmonic analyzer table

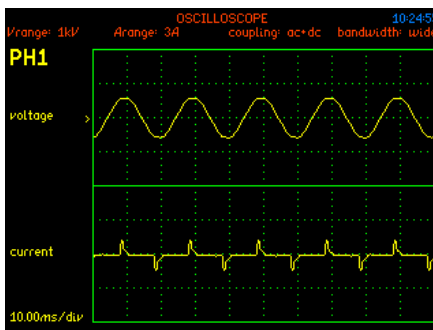

Oscilloscope - Voltage and Current display

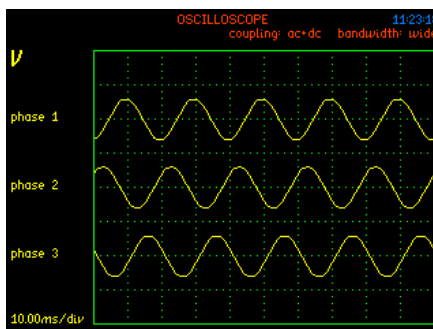

Three phase display of voltage or current

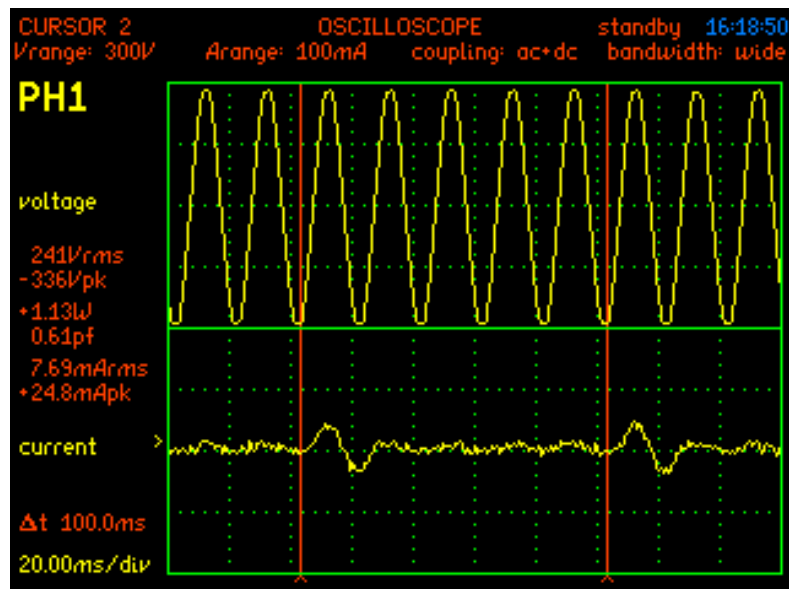

Oscilloscope Cursors - Enable cursors and display Vrms, Vpk, Watts, Power Factor, Arms and Apk

Note

In Harmonic Analyzer Mode, the PPA4500 provides up to 100 Harmonics with real time, table or bar graph presentation. Measurements are in absolute magnitude and percentage of fundamental with harmonic phase also available. The PPA5500 extends the harmonic range to 417 for aerospace applications and also includes a DFT based interharmonic analysis mode for aircraft standards testing (TVF105)

ACQUISITION SETTINGS

Auto-Ranging, Range Up Only or Manual PPA5500 PPA4500

Range modes are selectable

- ① Auto-Ranging Performs automatic switching of voltage and current ranges up and down depending on the level of the measured value with all inputs linked or ranged independently to ensure optimum accuracy
- ② Range up only Performs automatic ranging when the input is 120% of range, ranging up only
- ③ Manual No automatic ranging, user specifies the range in which to operate (used when input voltages and currents are known) or during inrush current testing

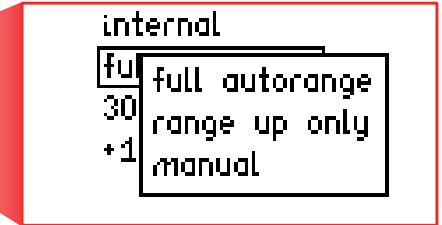
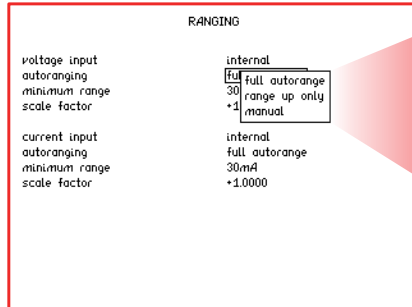
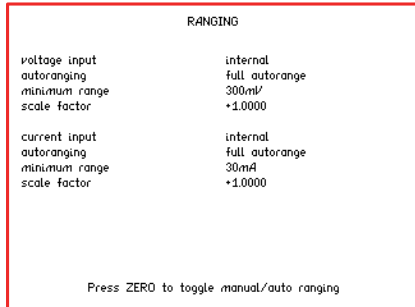

Independently Set Input Coupling PPA5500 PPA4500

Independently set input coupling so different methods of sensing can be implemented. Such as a CT on phase 1 and shunt sensing on phases 2 + 3

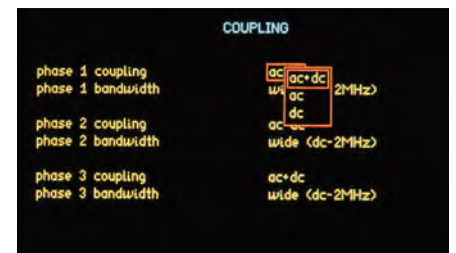
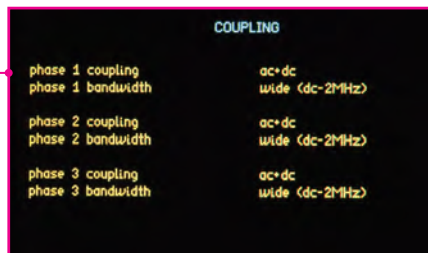
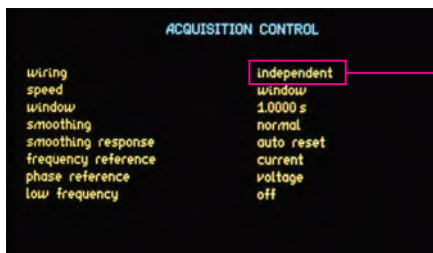

Wiring Settings PPA5500 PPA4500

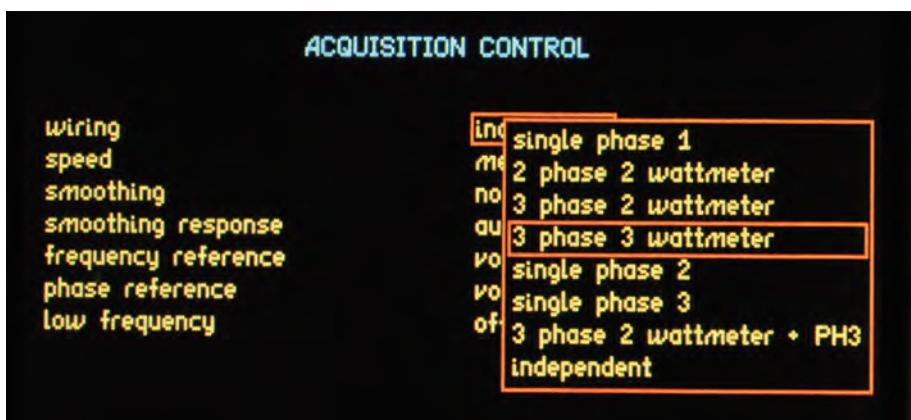

Various wiring arrangement settings to satisfy a complete range of setups found in power analysis

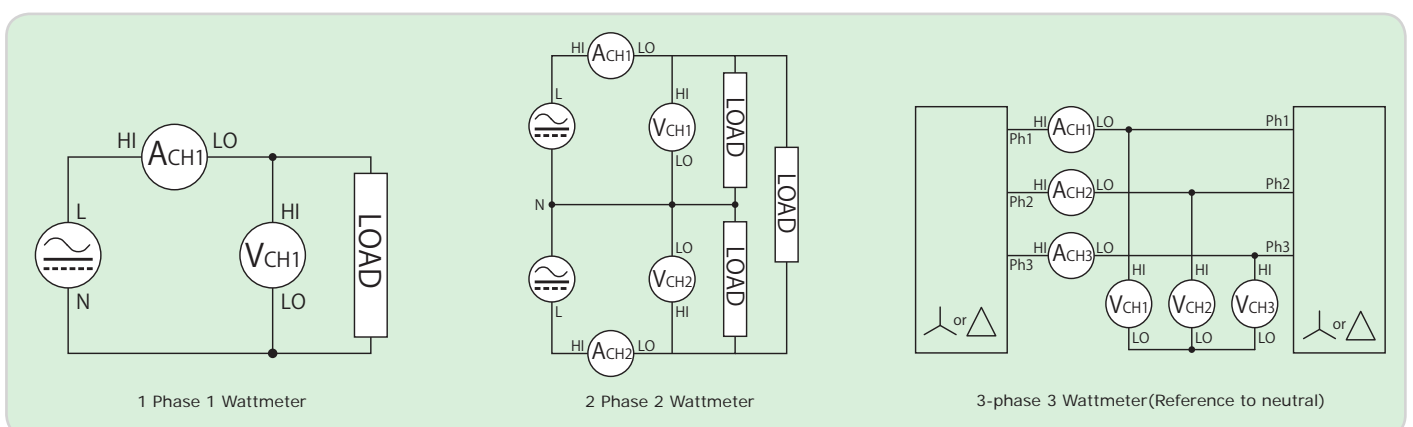

ACQUISITION SETTINGS

Bandwidth Settings PPA5500 PPA4500

- DC(DC-5Hz) DC measurements up to 5Hz
- Low(DC-200kHz) Basic power (50/60Hz) including harmonics of the fundamental while rejecting high frequency noise
- Wide(DC-2MHz) Wideband applications such as PWM inverter drives including all power components for true total power

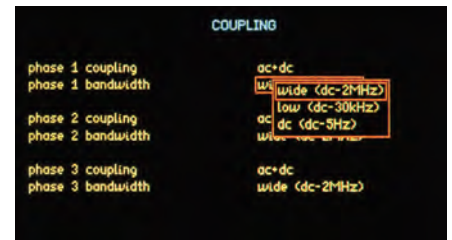

Example of independent wiring configuration showing 3 phase individual coupling settings

Note

The PPA45/5500 series includes a programmable digital filter that allows users to set a preferred bandwidth

Display Settings, Smoothing Response and Frequency Reference PPA5500 PPA4500

① Display update rate

Various settings for the display update rate (2ms ~ 100s) which also increases the smoothing when used together with the smoothing option. A 'window' option permits direct control of the measurement window size (Note: Minimum window size for PPA4500 - 10ms)

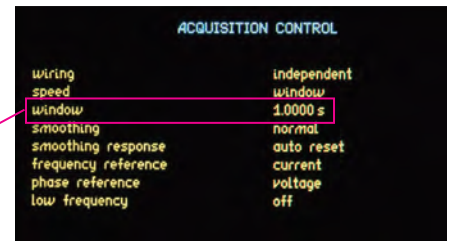
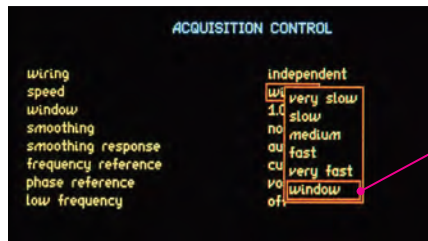

Example of setting the window, eg (50Hz set to 20ms)

② Smoothing settings

Working in conjunction with the speed setting, a smoothing filter can then be applied to the measurements. Normal and slow options are available which apply an increasing time constant to the output of the measurement window

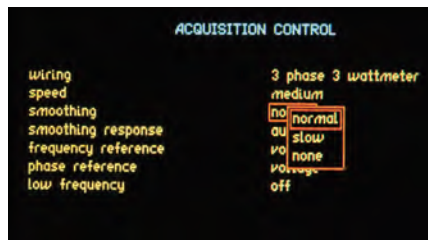

speed	update rate	normal time constant	slow time constant
Very Fast	1/80s	0.05s	0.2s
fast	1/20s	0.2s	0.8s
medium	1/3s	1.5s	6s
slow	2.5s	12s	48s
very slow	10s	48s	192s

- Display update speed settings
- Setting the filter (normal/slow)

Frequency Reference PPA5500 PPA4500

When making a precision measurement of ac power, correct synchronization with the fundamental frequency is essential. The PPA series provides a solution to frequency synchronization in a wide range of applications including Standby Power, Variable Speed Drives, Electronic Ballasts and DC to AC Inverters with the option to select voltage, current, speed or ac line input as the frequency reference. The PPA45/5500 series also provide fully independent frequency detection on all phase inputs

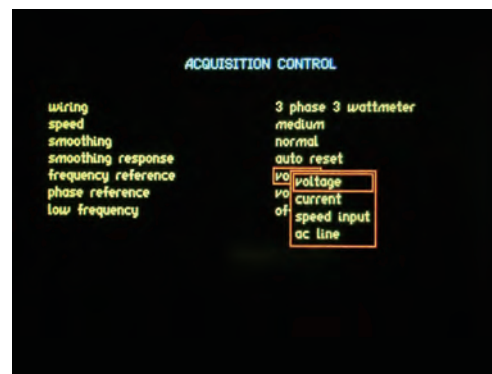

Frequency Reference

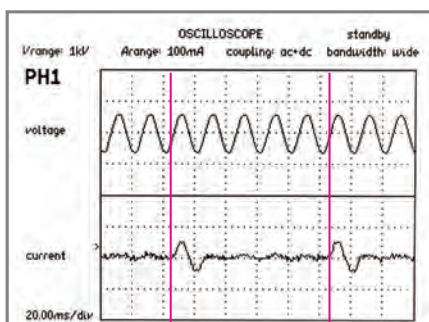

1:5 cycle (10Hz standby current period) Power measurements synchronized to low duty cycle current pulses of a power supply in standby mode

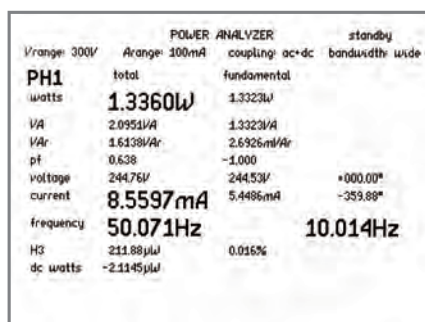

1:5 duty cycle standby power measurement cycle

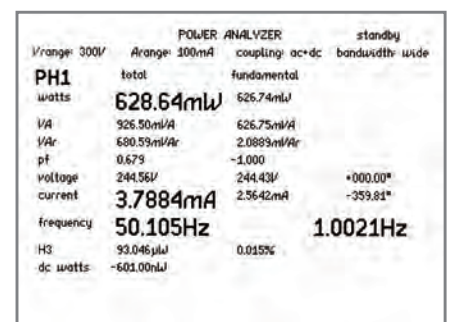

1:50 low duty cycle (1Hz) power measurement

APPLICATIONS

Application Modes PPA5500 PPA4500

In addition to the usual power measurements, various modes are pre programmed into the instrument including "PWM motor drive", "ballast lighting system", "inrush current", "power transformer", "Harmonics and Flicker*", "TVF105*" and "standby power"

*PPA5500 only

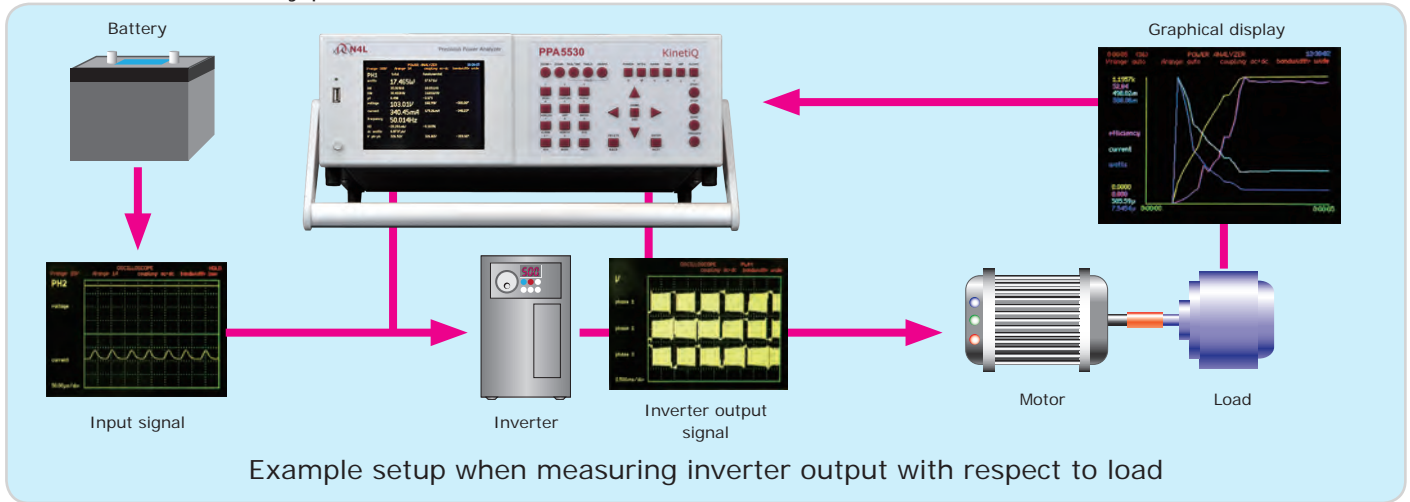

APPLICATION SELECTION

mode: PWM motor drive
press ENTER to load

frequency filter: 4kHz
frequency reference: voltage
low frequency: off
torque + speed: analogue speed

APPLICATION SELECTION

mode: PWM motor drive
press ENTER to load

frequency filter: 4kHz
frequency reference: current
low frequency: off
torque + speed: analogue speed

scale factor: +1.0000 Nm/V
offset: +0.0000 V

scale factor: 1.0000 rpm/V
offset: +0.0000 V

efficiency: mechanical / sum

Mode Selection

PWM torque and speed sensor selection

Scale factor of analogue speed and torque inputs

Inductance Loss Analysis PPA5500 PPA4500

An example of analysis of dynamic inductance losses

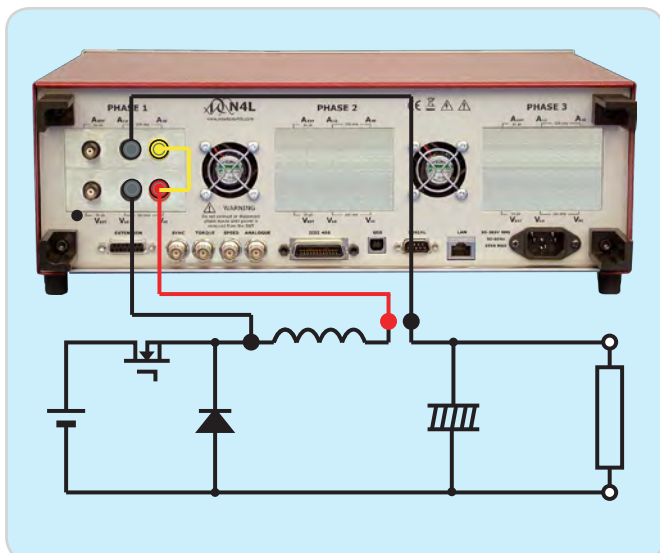

POWER ANALYZER			
Vrange: 30V		Arange: 300mA	
coupling: ac+dc		bandwidth: wide	
PH1	total	fundamental	
watts	23.813mW	11.320mW	
VA	325.76mVA	193.59mVA	
VAr	324.89mVAr	-193.26mVAr	
pf	0.073	+0.058	
voltage	3.6878V	2.2899V	+000.00°
current	88.335mA	84.539mA	-086.65°
frequency	30.000kHz		
H3	4.9618mW	43.83%	
dc watts	68.838µW		

Real time data

APPLICATIONS

■ PWM Motor Drive Evaluation PPA5500 PPA4500

The PPA5500 is the perfect solution for Inverter Drive evaluation and analysis. Utilising proprietary digital filtering algorithms, the N4L power analyzer range offers unrivalled performance. The PPA5500 can be used in conjunction with external current sensors such as the WR5000 - a 1MHz 5000A Rogowski Coil in high current applications. Inverter efficiency is available via either 3 Phase 2 Wattmeter method + CH3 (utilising CH3 for the DC Bus measurement). Alternatively a second single phase PPA can be connected to the DC Bus and the two analyzers are configured in a Master Slave arrangement, all data is available via N4L Software.

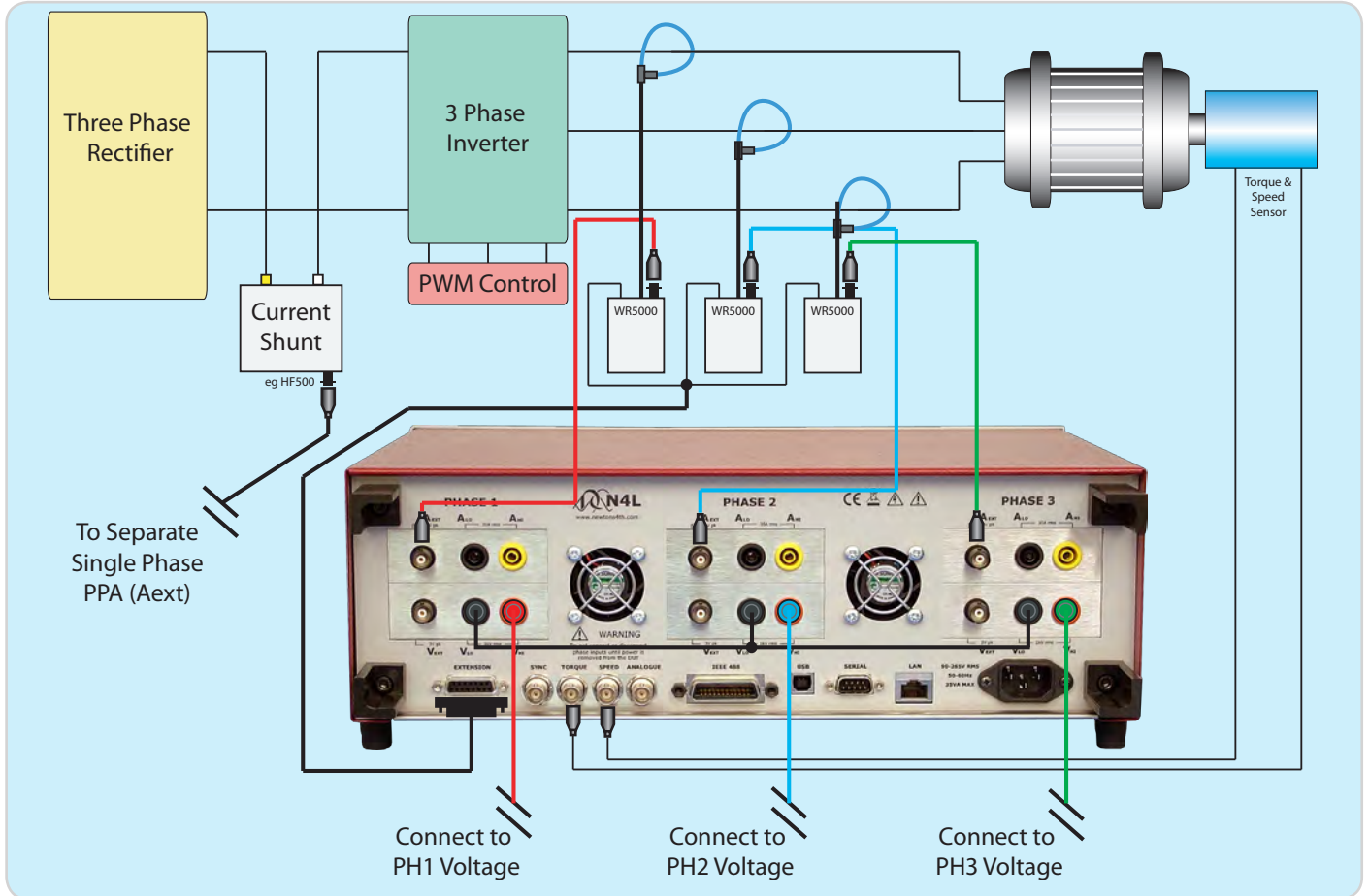

■ High Speed Analysis PPA5500

The PPA5500 features the fastest signal processing on the market, this enables high speed tracking of changing inverter drive frequencies and power parameters during ramp up and ramp down conditions, for example in electric vehicle applications. N4L's free to download software package (PPALoG) offers datalog intervals down to 5ms, providing fast, no-gap real-time data direct to software.

Rapid ramp up analysis

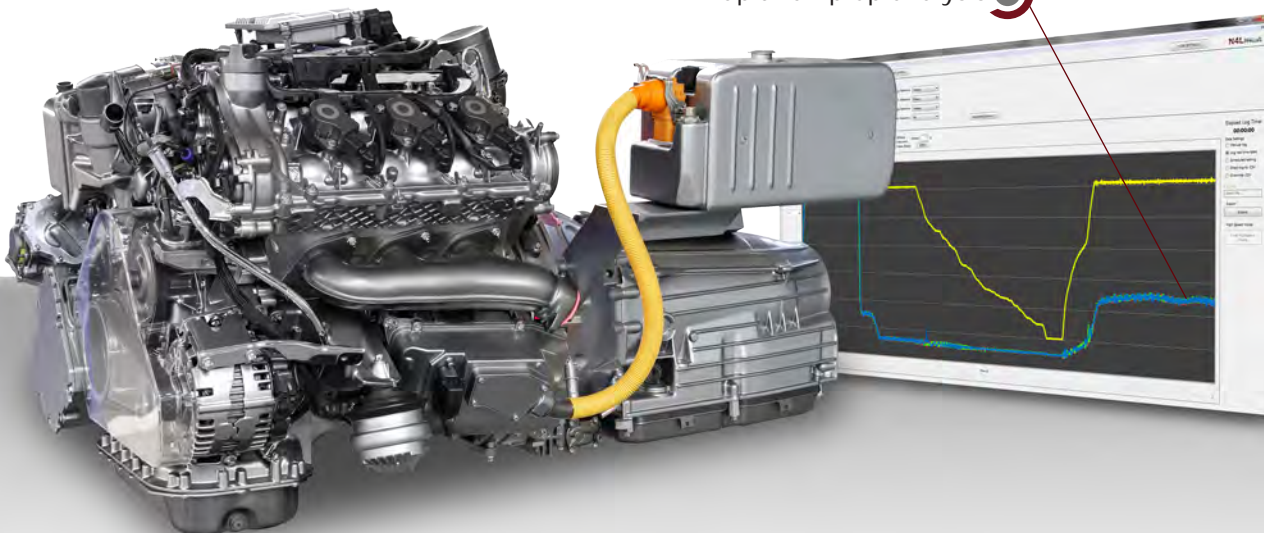

APPLICATIONS

■ Standby Power (IEC62301 Ed 2.0) PPA5500 PPA4500

The PPA4520 and PPA5520 units offer unrivalled dynamic range which enables the user to comply with IEC62301 and Energy Star testing standards. Utilising "Standby Power Mode" the PPA employs proprietary standby power signal processing algorithms to provide accurate no gap analysis of high crest factor (CF) signals, importantly the entire N4L power analyzer range benefit from a guaranteed accuracy specification up to a crest factor of 20.

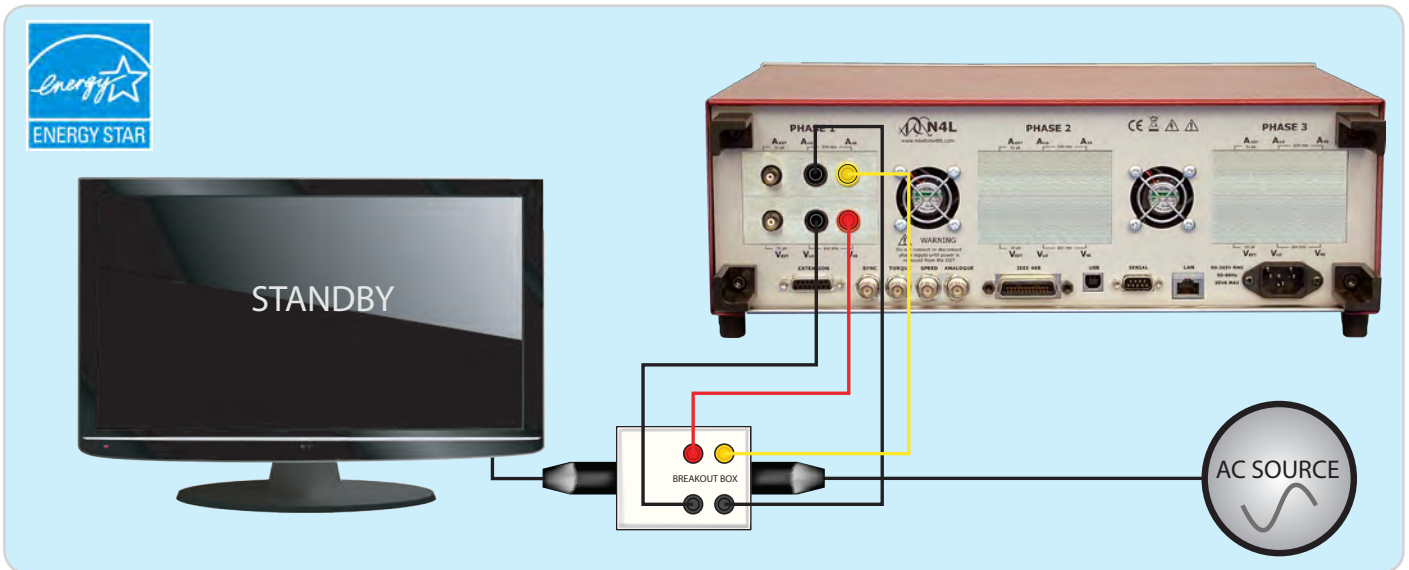

■ Guaranteed Accuracy up to Crest Factor 20 PPA5500 PPA4500

As stated in IEC62301, typical standby power current waveform crest factors can exceed values of 10. In such cases it is important for the Power Analyzer to guarantee accuracy at crest factors expected of the application under test.



Newtons4th are the only Power Analyzer Manufacturer in the world* to provide ISO17025 calibration certificates on all new Power Analyzers as standard. Our ISO17025 Schedule of Accreditation includes Voltage, Current, Phase, Power, Harmonics and Flicker. With traceable certification of power accuracy down to 0.5W, N4L offer the ideal measurement solution for certified standby power measurement.

■ LED Driver Efficiency PPA5500 PPA4500

The PPA4520 and PPA5520 offer an ideal solution for LED driver efficiency measurements, dimming techniques such as reverse phase control are easily analyzed by the N4L Power Analyzers.

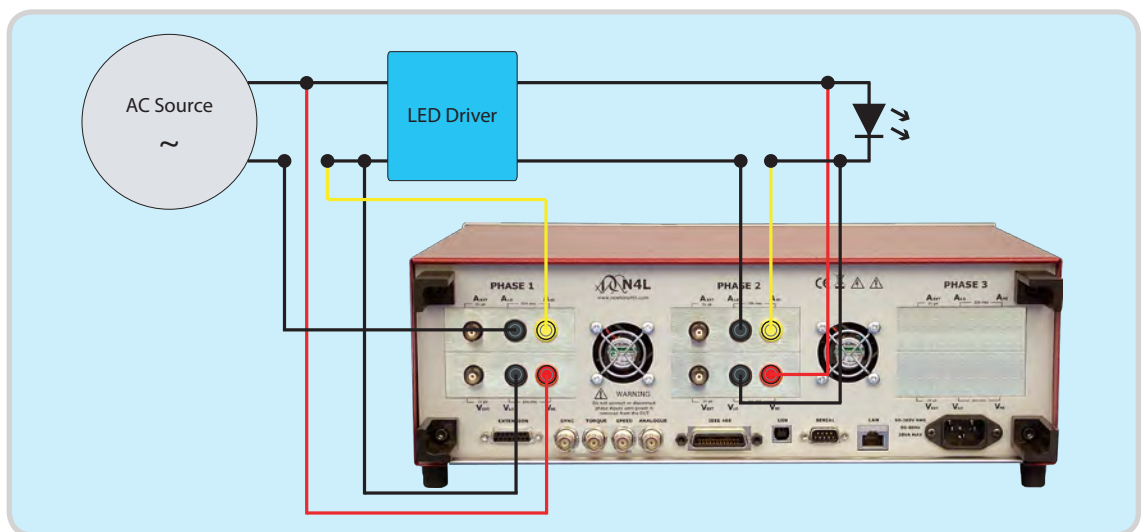

Efficiency can be viewed either directly on the PPA display using the "Phase/Next Phase" efficiency option or calculated in PPALog software.

APPLICATIONS

Power Transformer Loss Testing PPA5500 PPA4500

The PPA4500 and PPA5500 series of Power Analyzers exhibit the best phase accuracy on the market, with a basic accuracy of 0.005°, low power factor core loss testing of transformers is both accurate and repeatable. This is achieved as a result of both sophisticated analogue input design and proprietary digital signal processing techniques. Low power factor certification to UKAS ISO17025 is also available directly from N4L's accredited calibration laboratory.

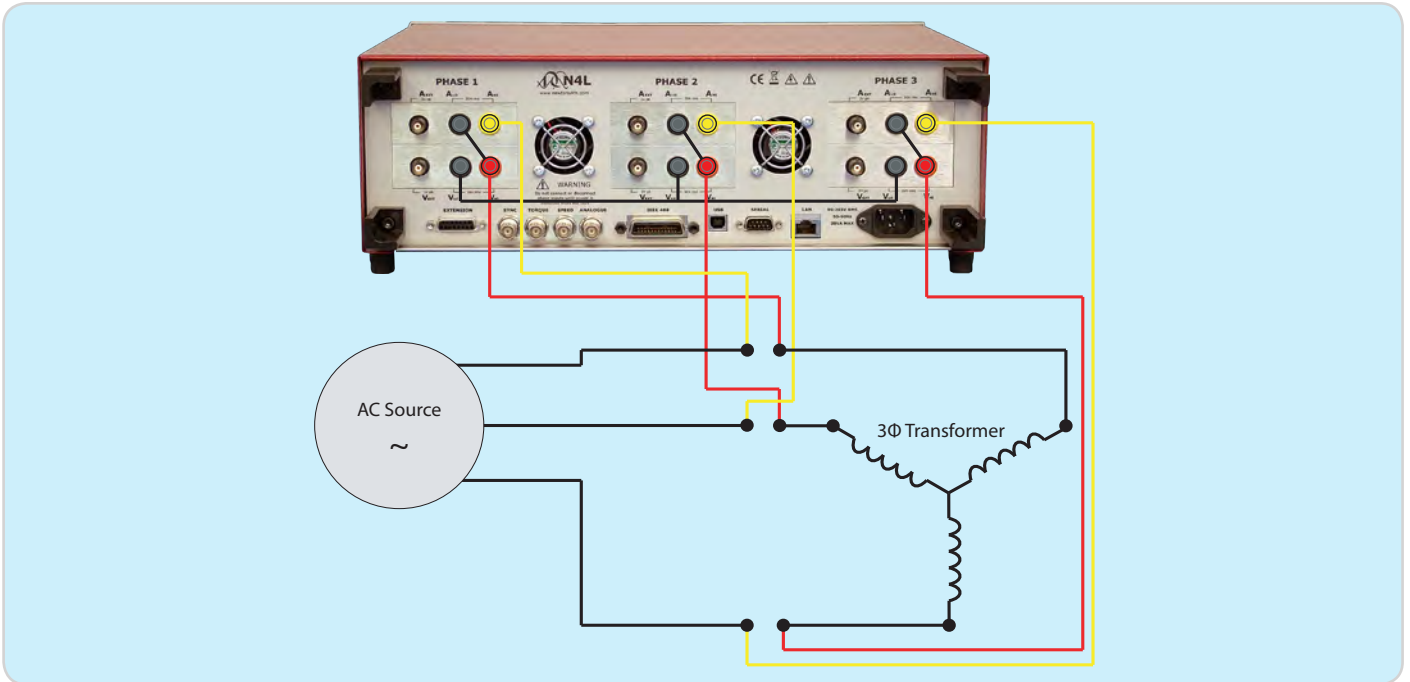

Aircraft Avionics Industry - 417 Harmonics + Interharmonics PPA5500

The PPA5500, featuring high speed FPGA and DSP processors is able to compute up to 417 Harmonics and also meet interharmonic measurement requirements of ABD0100.1.8. The Harmonic Analyzer mode and special TTVF105 Interharmonic mode in the PPA5500 offer the Avionics Engineer an accurate, simple to use solution.

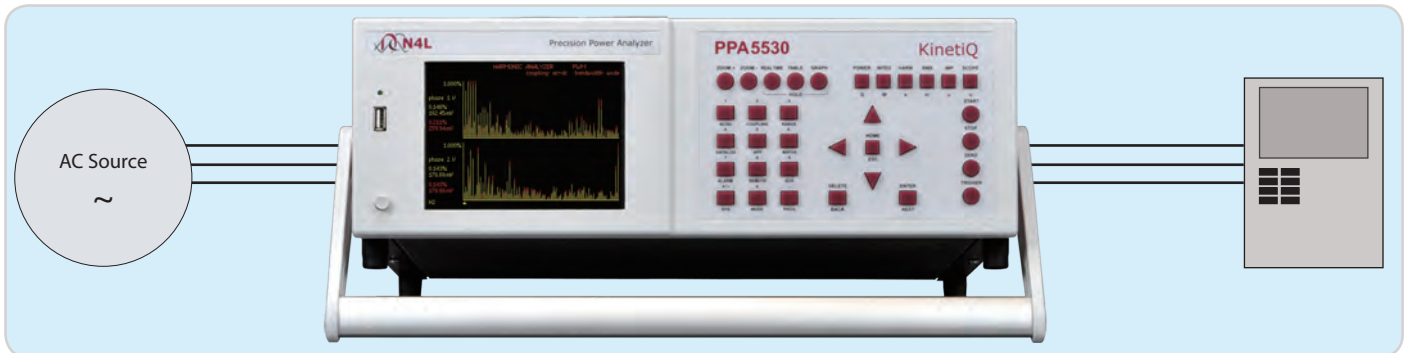

Example ABD0100.1.8 Interharmonic Results, up to 150kHz (Sample Waveform analyzed for illustration)

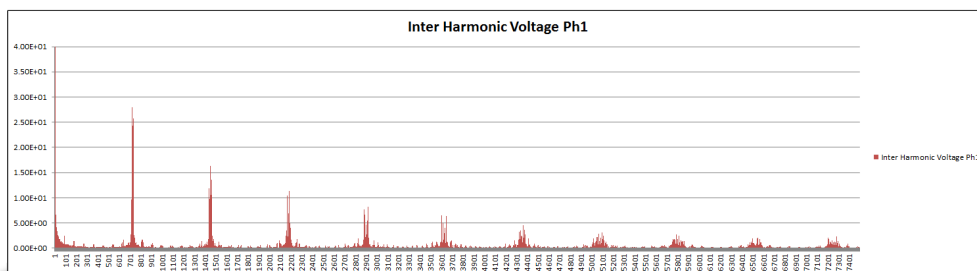

Note: PPA4500 up to 100 Harmonics

Solar Inverter Performance Analysis PPA5500 PPA4500

The PPA5500 and PPA4500 provide a highly accurate solar inverter analysis and evaluation solution, featuring independent frequency detection N4L Power Analyzers exhibit the ability to synchronise to the 50/60Hz output signal along with with the DC input signal from the solar array. Both efficiency of the inverter, quality of the AC output and many other performance parameters can be recorded.

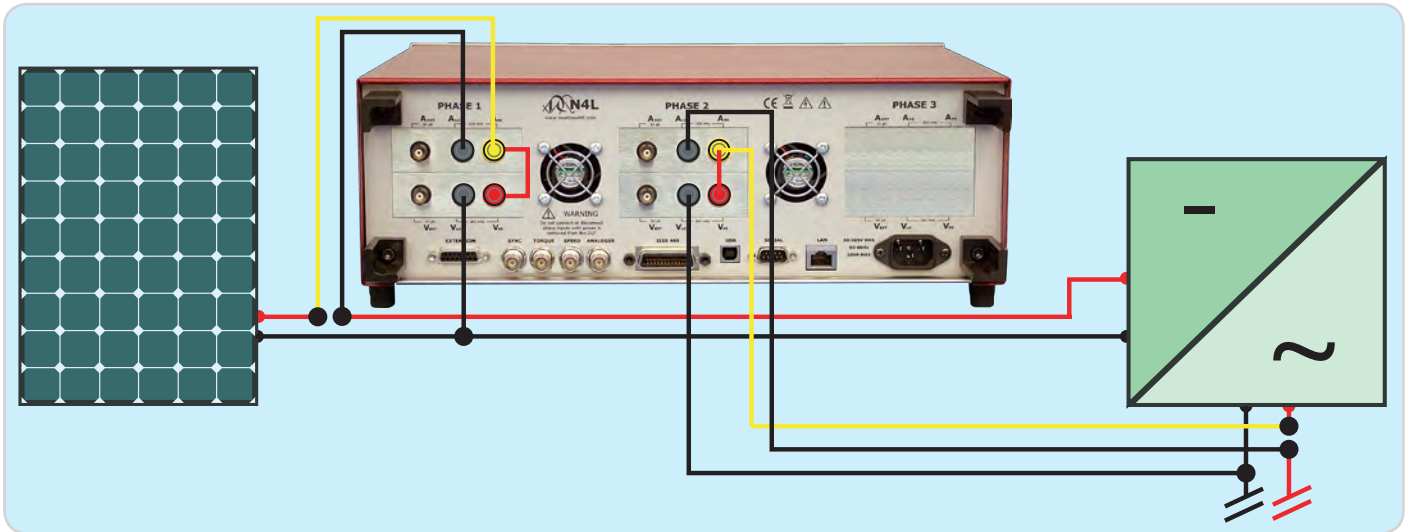

Inrush Current PPA5500 PPA4500

Accurate inrush current measurements rely upon two factors aside from fundamental measurement accuracy, these are gapless measurement and a high sampling rate;

1. Gapless Measurement - Inrush waveforms by their nature are transient; gapless measurement is vitally important in order to ensure that inrush waveform data is not missed.
2. High Sampling Rate - When working with mains frequencies, many power analyzers have low sample rates due to the computation of measured values from a data block of finite size. The PPA4500 and PPA5500 utilise a proprietary real time signal processing technique that maintains full 2.2Ms/s sample rate irrespective of the measured load frequency, ensuring that high frequency events are captured without aliasing.



Example Inrush current data, datalogging at nominally 20ms intervals directly to PPALoG

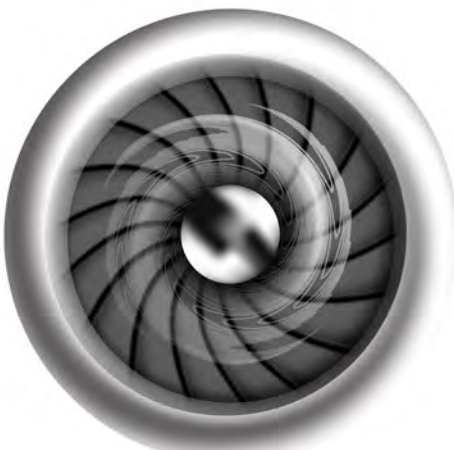
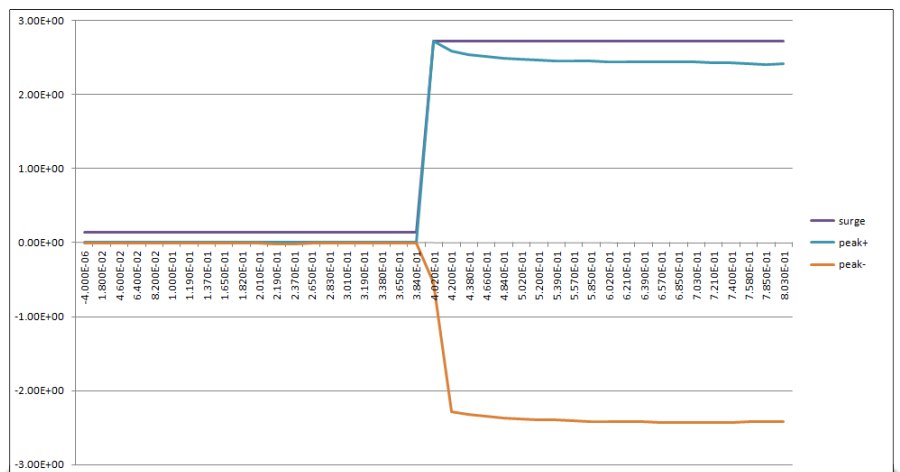

Calibration and ISO17025 Certification

■ UKAS PPA5500 PPA4500

Newtons4th are an accredited UKAS Calibration laboratory, all PPA4500 and PPA5500 Power Analyzers are supplied with an ISO17025 UKAS Calibration Certificate as standard. Calibration of N4L Power Analyzers is an integral and important part of our service to our clients, we offer quick turnaround times at a competitive price. Re-Calibration is also available at our international offices and various distributors throughout the world*.



■ Schedule of Accreditation PPA5500 PPA4500

N4L's schedule of accreditation to ISO17025 is wide ranging and an overview of the schedule is detailed below, for more specific information please see the UKAS website to view the full accreditation schedule.

ISO17025 UKAS Accreditation Schedule		
	Signal Amplitude	Frequency Range
Voltage Sine Amplitude	1V to 1008V	16Hz to 850Hz
Voltage Harmonic Amplitude	0V to 302V	16Hz to 6kHz
Current Sinewave Amplitude	100mA to 48A	16Hz to 850Hz
Current Harmonic Amplitude	0A to 15A	16Hz to 6kHz
Current to Voltage Phase Angle	-180° to +180°	16Hz to 850Hz
Apparent Power (VA Product)	100mVa to 48.4kVA	16Hz to 850Hz
AC Power	0W to 48.4kW	16Hz to 850Hz
Current Harmonic Amplitude to IEC61000-4-7	0A to 6A	16Hz to 6kHz
Flicker to IEC61000-4-15	Pinst(Sinusoidal Modulation)	As per IEC61000
	Pinst(Rectangular Modulation)	
	Pst	
	Frequency Changes	
	Distorted Voltage with Multiple Zero Crossings	
	Harmonics with Sidebands	
	Phase Jumps	
	Rectangular Changes with Duty Cycle	

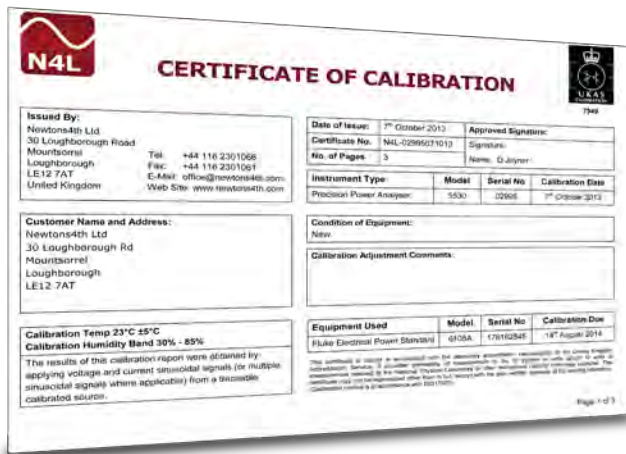

Due to the specialist nature of Power Measurement Instrumentation Calibration, N4L utilise both commercially available calibration equipment (such as the Fluke 6105A for UKAS Certification) along with N4L bespoke designed signal generation equipment in order to calibrate our instruments over the full frequency range (up to 2MHz). Calibration over the full frequency range is uncommon given that such signal generation equipment is not commercially available. When supplied with an N4L analyzer, all customers will receive a calibration certificate covering the complete frequency range.



*UKAS Calibration is available from N4L UK HQ only, details for calibration performed at other locations is subject to local accreditation, please contact your local office for more details.

Ranging Principles

9 Stage Solid State Ranging System - PPA5500 PPA4500

Combining highly linear voltage attenuator and current shunt designs with a proprietary 9 stage (PPA5500) or 8 stage (PPA4500) solid state ranging system on every phase input, the PPA series achieve a uniquely wide dynamic range, with no need to switch between voltage attenuators or current shunts when ranging up or down.

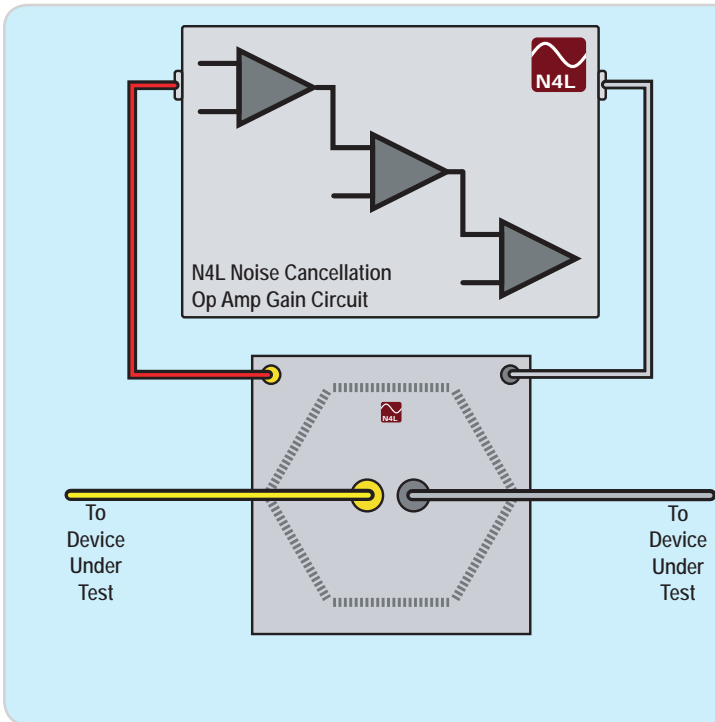

Design features:

- Single attenuator on each voltage input
- High impedance low capacitance
- Single shunt on each current input
- Low impedance low inductance
- Auto peak detect
- High speed solid state ranging
- High Noise rejection
- Auto DC offset trimming

Benefits:

- Overload protected on any range
- Low shunt affect on voltage connections
- Low voltage burden on current connections
- Market leading phase accuracy
- Peak detect ranging ensures no signal clipping
- Low attenuator/shunt operating temperature
- Fast range switching
- Constant frequency response on all ranges
- Signal can be applied with instrument powered off

Auto Peak Ranging Ensures Complete Waveform Analysis PPA5500 PPA4500

It is often overlooked that for an instrument to correctly calculate power parameters, the entire waveform must be digitised for analysis. The Peak Ranging system employed by all N4L Power Analyzers ensures that the entire waveform is digitised and the correct power parameters are calculated.

Example RMS Ranging system, commonly used in older instrument designs

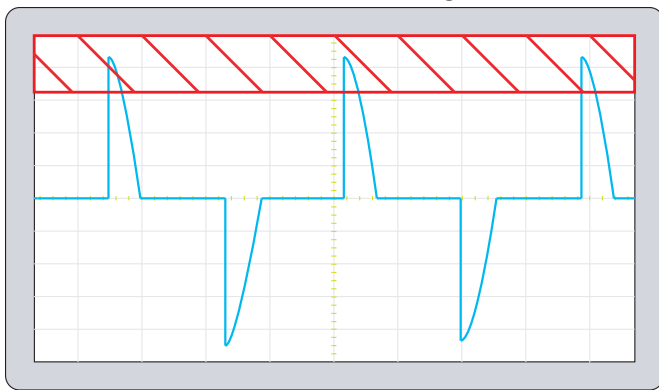

Waveform within red hashed area is clipped by an RMS ranging system and fixed crest factor setting

Modern Peak Ranging System, implemented on all N4L Power Analyzers

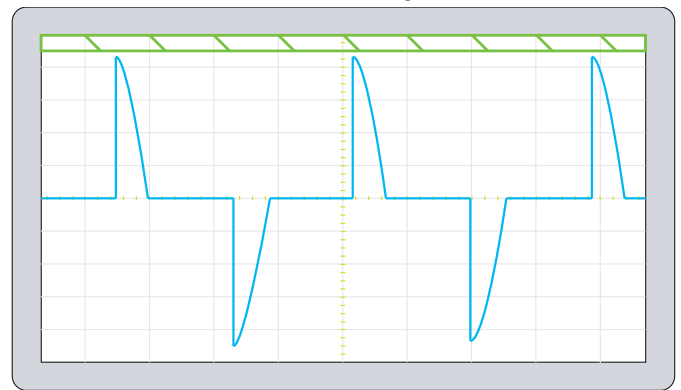

Peak Ranging system auto-detects the peak of the input signal and selects the ideal range

Note

An RMS Ranging system requires the user to have prior knowledge of the crest factor which in many applications is not practical, either because the user cannot reasonably be expected to know this value before a measurement, or because the crest factor is changing during a measurement period. The ideal ranging system is therefore based upon peak detection which does not require the user to be concerned with a crest factor setting. While many RMS ranging systems are only guaranteed to support a Crest Factor of 6, all N4L Power Analyzers guarantee to auto-range with any crest factor and maintain full accuracy with a CF of at least 20. While waveforms with a true CF above 20 are very unusual, 'auto range up' or 'manual' ranging combined with a market leading range sensitivity enables the PPA to achieve a dynamic range equal to a CF >300.

PC CONTROL AND DATA ACQUISITION

PC Software PPA5500 PPA4500

Analysis carried out by the instrument can easily be transferred to a PC via USB, RS232 or LAN

① **PPALoG** Exceptional flexibility and ease of use with all the functions included in the original PPAcomm program plus multiple instrument control for 4-12 phase applications and data export to Text file, Excel, Bitmap or Clipboard

The screenshot shows the PPA Dual Data Logger software interface. It includes a 'SETTINGS' section for configuration, a 'REAL TIME' display showing 'PPA1 - RESULTS' and 'PPA2 - RESULTS' with various parameters like voltage, current, and power. A 'REAL TIME DATALOG' table is visible, capturing up to 60 measured functions per line. The interface also features options for saving logs to CSV and exporting data.

a. Measurement parameters are chosen by the user from tick box options
 b. Real time results can be displayed as latest value, table or graph
 c. Datalogging results are then saved in the selected format

Simultaneous display of master and slave units

Real time Datalog

Capture up to 60 measured functions per line

Data Export options

The screenshots illustrate data export options. On the left, a Bitmap image of a PPA screen is shown. In the center, a Microsoft Excel spreadsheet displays measurement tables with columns for TIME, rms V PH1, rms I PH1, watts PH1, VA PH1, VAR PH1, frequency PH1, power factor PH1, and rms V PH2. On the right, the software's export menu is shown, with options for saving logs to CSV, exporting to Excel, and exporting to a text file.

A Bitmap image of any PPA screen image can be copied to clipboard or imported directly into documents

Measurement tables generated by the data logging function can be exported directly to Excel

② **PPA Standby Power** Full compliance testing to IEC62301. Meets or exceeds the requirements and methodology of U.S. EPA (Energy Star), U.S.DOE, California Energy Commission (CEC), among others.



The screenshots show the N4L Standby Power test screen and a detailed test report. The test screen displays real-time updates of IEC62301 criteria, including Power (W), Crest Factor, Average Power (W), and Accumulated Power (Whr). The test report provides a comprehensive overview of the test, including device information, test conditions, and test results.

Standby power test screen with real time update of IEC62301 criteria

On completion of the standby test, a full test report can be exported directly to a spreadsheet

PC CONTROL AND DATA ACQUISITION

Fully Compliant IEC61000-3-2/3-3 Harmonics and Flicker Testing PPA5500

The PPA55xx series Power Analyzers provide fully compliant ISO17025 certified Harmonics and Flicker testing, Newtons4th offer the ability to display the results of many tests within the instrument and all tests to PC software.

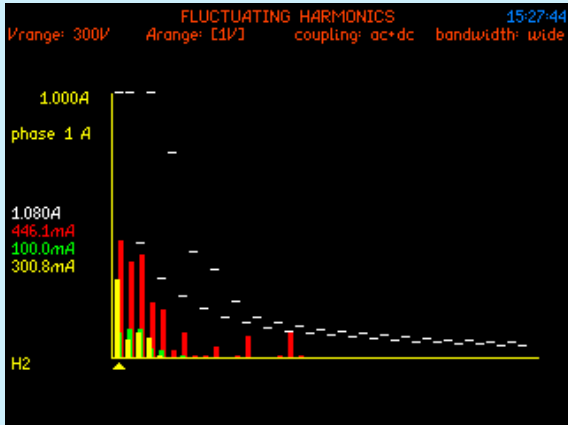

Limits are shown in the graph mode where current, average and max values are updated. The class of the device under test (Harmonics) can be selected in the application menu.



After the test is complete, the unit will display a Pass or Fail message. A screen shot can be downloaded to software, alternatively the test can be controlled and monitored in software.

More information is available in a separate IEC61000 Harmonics and Flicker brochure. Dedicated models called the PPA5511 and PPA5531 include low impedance shunts (see ** on page 20) and adjusted filter response for full compliance testing.

Connection Interface PPA5500 PPA4500

RS232 (standard), USB (standard), LAN (standard on PPA5500), GPIB (standard on PPA5500)



Data Logging PPA5500 PPA4500

Utilizing sophisticated frequency detection techniques, synchronization with the fundamental AC waveform is automatically achieved. Datalog intervals can be set from 2ms with measurements saved to a PC or internal memory.

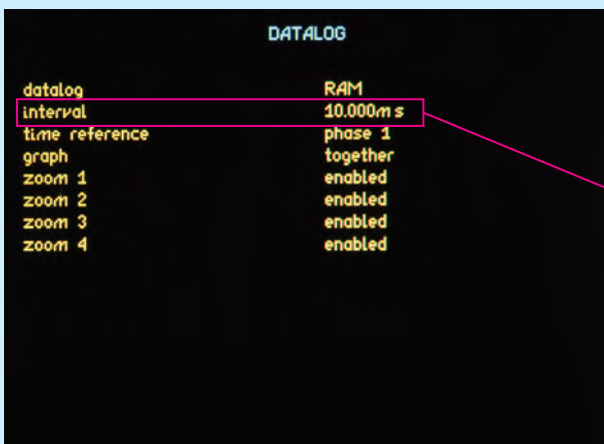

Datalog menu, interval set to 10ms

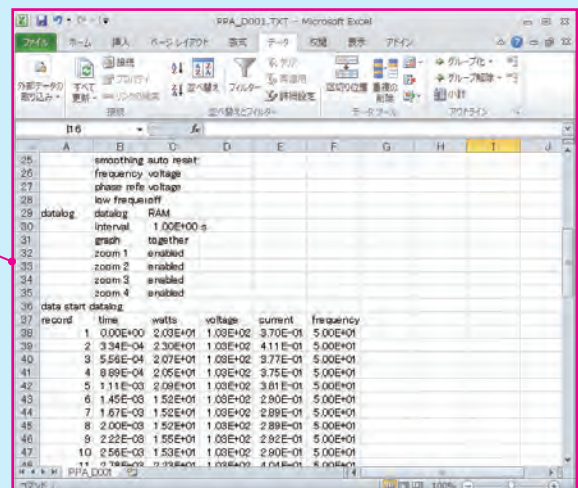

SPECIFICATION

	PPA4500	PPA5500			
Frequency Range	DC,10mHz ~ 2MHz - PPA4500-LC(10Arms), PPA4500(30Arms) DC,10mHz ~ 1MHz - PPA4500-HC(50Arms)	DC,10mHz ~ 2MHz - PPA5500-LC(10Arms), PPA5500(30Arms) DC,10mHz ~ 1MHz - PPA5500-HC(50Arms)			
Voltage Input					
Internal	Range	1Vpk ~ 3000Vpk(1000Vrms) in 8 ranges (240Vrms within 300Vpk range, using 20% overrange)	300mVpk ~ 3000Vpk(1000Vrms) in 9 ranges (240Vrms within 300Vpk range, using 20% overrange)		
	Accuracy	0.03% Rdg+0.04% Rng+(0.004%×kHz Rdg)+5mV	0.01% Rdg+0.038% Rng+(0.004%×kHz Rdg)+5mV		
External	Range	1mVpk ~ 3Vpk in 9 ranges [BNC connector 3Vpk max input]	300μVpk ~ 3Vpk in 9 ranges [BNC connector 3Vpk max input]		
	Accuracy	0.03%Rdg+0.04%Rng+(0.004%×kHz Rdg)+3μV	0.01%Rdg+0.038%Rng+(0.004%×kHz Rdg)+3μV		
Current Input					
Internal	10Arms Low Current (PPA5500-LC) 4mm safety connectors	Ranges	10mApk ~ 30Apk(10Arms) in 8 ranges	Ranges	3mApk ~ 30Apk(10Arms) in 9 ranges
		Accuracy	0.03% Rdg+0.04% Rng+(0.004%×kHz Rdg)+ 30μA	Accuracy	0.01% Rdg+0.038% Rng+(0.004%×kHz Rdg)+ 30μA
	30Arms Current (PPA5500) 4mm safety connectors	Ranges	100mApk ~ 300Apk(30Arms) in 8 ranges	Ranges	30mApk ~ 300Apk(30Arms) in 9 ranges
		Accuracy	0.03% Rdg+0.04% Rng+(0.004%×kHz Rdg)+ 300μA	Accuracy	0.01% Rdg+0.038% Rng+(0.004%×kHz Rdg)+ 300μA
	50Arms High Current (PPA5500-HC) **	Ranges	300mApk ~ 1000Apk(50Arms) in 8 ranges	Ranges	100mApk ~ 1000Apk(50Arms) in 9 ranges
		Accuracy	0.03% Rdg+0.04% Rng+(0.004%×kHz Rdg)+ 900μA	Accuracy	0.01% Rdg+0.038% Rng+(0.004%×kHz Rdg)+ 900μA
External input (External shunt Current sensor)	BNC Connector (Max input 3Vpk)	Ranges	1mVpk ~ 3Vpk in 8 ranges	Ranges	300μVpk ~ 3Vpk in 9 ranges
		Accuracy	0.03% Rdg+0.04% Rng+(0.004%×kHz Rdg)+ 3μV	Accuracy	0.01% Rdg+0.038% Rng+(0.004%×kHz Rdg)+ 3μV
Phase Accuracy	0.005deg+(0.01deg×kHz) [PPA45/5500-LC(10Arms), PPA45/5500(30Arms)] 0.01deg+(0.02deg×kHz) [PPA45/5500-HC(50Arms)]				
Power Accuracy					
	[0.04%+0.05%/pf+(0.01%×kHz)/pf] Rdg+0.04%VA Rng		[0.03%+0.03%/pf+(0.01%×kHz)/pf] Rdg+0.03%VA Rng		
40-400Hz	[0.03%+0.04%/pf+(0.01%×kHz)/pf] Rdg+0.03%VA Rng		[0.02%+0.03%/pf+(0.01%×kHz)/pf] Rdg+0.02%VA Rng		
General					
Crest Factor	20(Voltage and Current)				
Sample Rate	2.2Ms/s on all channels, No-Gap				
IEC Modes	IEC62301 Standby Power		IEC61000 Harmonics and Flicker, IEC62301 Standby Power		
Application Modes	PWM Motor Drive, Ballast, Inrush, Power Transformer, Standby Power		PWM Motor Drive, Ballast, Inrush, Power Transformer, Standby Power, Fluctuating Harmonics, Flicker Meter, TVF105 Interharmonics		
CMRR - Common Mode Rejection Ratio					
	250V @ 50Hz - ≥ 1mA (150dB)				
	100V @ 100kHz - ≥ 3mA (130dB)				
Measurement Parameters					
	W ,VA ,Var ,pf ,V & A - rms ,rectified mean ,AC ,DC ,Peak ,Surge ,Crest Factor ,Form Factor ,Star to Delta Voltage, +ve Pk, -ve Pk				
	Frequency (Hz), Phase (deg), Fundamentals, Impedance				
	Harmonics, THD, TIF, THF, TRD, TDD				
	Integrated Values, Datalog, Sum and Neutral values				
Datalog - Up to 4 user selectable measurement functions (30 with optional PC software)					
Datalog Window	No-Gap analysis, Minimum window 10ms		No-Gap analysis, Minimum window 2ms		
Memory	16,000 records		10M records into flash RAM (Non-Volatile)		
Communication Ports					
RS232	Baud rate up to 38.4kbps,RTS/CTS flow control				
LAN	(Option L) 10/100 Base-T Ethernet auto sensing		(Fitted as standard) 10/100 Base-T Ethernet auto sensing		
GPIB	(Option G) IEEE488.2 Compatible		(Fitted as standard) IEEE488.2 Compatible		
USB	USB 2.0 and 1.1 compatible				
Analogue Output	Bipolar ±10V(BNC)				
Speed Input	BNC Bipolar±10V or Pulse count 1Hz to 1MHz 0.01% Rdg				
Torque	BNC Bipolar±10V or Pulse count 1Hz to 1MHz 0.01% Rdg				
Sync	4 ~ 6 Phase measurement (Master/Slave)				
Extension	4 ~ 6 Phase (Master/Slave) + Auxiliary				
Standard Accessories					
Leads	Power, RS232, USB		Power, RS232, USB, GPIB		
Connection Cables	36A 1.5m long 4mm stackable terminals 1x red, 1x yellow and 2x black per phase (1x red, 1x black with HC version)				
Connection Clips	4mm terminated alligator clips - 1x red, 1x yellow and 2x black per phase (1x red and 1x black per phase with PPA5500-HC version)				
CD-ROM	CommView2 (RS232/USB/LAN), Command line, Script based communication software				
Documents	User manual, Communications manual, Calibration certificate, Quick start guide				
Mechanical/Environmental					
Display	320×240 dot full colour TFT, White LED Backlit				
Dimensions	130H×400W×315D mm excluding feet				
Weight	5.4kg(1 Phase), 6kg(3 Phase)				
Safety Isolation	1000Vrms or DC(CATII), 600Vrms or DC(CATIII)				
Power supply	90 ~ 265Vrms, 50 ~ 60Hz, 40Vamax				
Operating Conditions	23°C ± 5°C Ambient Temperature (or air intake temperature when rack mounted), 20-90% Non-Condensing Relative Humidity, Temperature coefficient ±0.01% per °C of reading at 5-18°C and 28-40°C				

SPECIFICATION

	PPA4500	PPA5500
Harmonic Specification		
Bandwidth	DC,10mHz~2MHz - PPA4500-LC(10Arms), PPA4500(30Arms) DC,10mHz~1MHz - PPA4500-HC(50Arms)	DC,10mHz~2MHz - PPA5500-LC(10Arms), PPA5500(30Arms) DC,10mHz~1MHz - PPA5500-HC(50Arms)
No. of Harmonics	100	417
Sampling Frequency	2Ms/s	
Signal Processing	DFT (Discret Fourier Transform)	
Crest Factor	20	
Power Factor	0 to 1	
Harmonic Accuracy		
Voltage	0.03% Rdg+0.04% Rng+(0.004%×kHz)+5mV	0.01% Rdg+0.038% Rng+(0.004%×kHz)+5mV
Current	PPA4500-LC 0.03% Rdg+0.04% Rng+(0.004%×kHz Rdg)+10uA PPA4500 0.03% Rdg+0.04% Rng+(0.004%×kHz Rdg)+300uA PPA4500-HC 0.03% Rdg+0.04% Rng+(0.004%×kHz Rdg)+900uA	PPA5500-LC 0.01% Rdg+0.038% Rng+(0.004%×kHz Rdg)+10uA PPA5500 0.01% Rdg+0.038% Rng+(0.004%×kHz Rdg)+300uA PPA5500-HC 0.01% Rdg+0.038% Rng+(0.004%×kHz Rdg)+900uA
Harmonic Accuracy (above) still applies with Frequency Filter set		
IEC61000 Harmonic Accuracy		
Voltage	-	0.2% Rdg+0.038% Rng+(0.004%×kHz Rdg)+5mV
Current	-	PPA5500-LC 0.2% Rdg+0.038% Rng+(0.004%×kHz Rdg)+10uA PPA5500 0.2% Rdg+0.038% Rng+(0.004%×kHz Rdg)+300uA PPA5500-HC 0.2% Rdg+0.038% Rng+(0.004%×kHz Rdg)+900uA
Cycle by Cycle Analysis direct to PC - 2Ms/s sample rate (Window setting)		
Data Rate	10ms	5ms
Cycle by Cycle Analysis direct to Internal RAM - 2Ms/s sample rate		
Data Rate	10ms	2ms
Voltage Attenuator Overload Capability		
20ms	4.2kVpk (3kVrms)	4.2kVpk (3kVrms)
5s	3.1kVpk (2.2kVrms)	3.1kVpk (2.2kVrms)
Continuous	3kVpk (1kVrms)	3kVpk (1kVrms)
Minimum Current Measurement at Full Accuracy		
PPA5500-LC	45uArms	45uArms
PPA5500	220uArms	220uArms
PPA5500-HC	700uArms	700uArms

ACCESSORIES SUPPLIED AS STANDARD

Leads and Interfacing	
Type	Specification
36A Connection lead set	1.5 Meter - 36A lead set with 4mm stackable safety terminals 1x Red, 1x Yellow and 2x Black per phase plus alligator clips
36A 4mm to spade (Option)	1.5 Meter - 36A lead set with 4mm to spade for HC terminals
RS232 cable	RS232 9pin serial Cable
USB cable	USB 2 Meter A male to B male
USB to 9-pin RS232 (Option)	USB ~ 9-pin RS232 Serial Converter
Master-Slave cable (Option)	Leads for connecting 2x PPA5500 in master/slave mode
GPIB Cable (PPA5500)	GPIB Interface Cable

Documents (Standard)	
Type	Specification
Calibration/Test & Inspection Certificate	PPA Certificate of Calibration
UKAS ISO17025 Certificate	UKAS ISO17025 Certificate of Calibration
Spare set of manuals	User manual Comms manual

OPTIONAL ACCESSORIES

PC Software (Optional CD, Free to Download)	
Type	Specification
PPALoG	PC control and data acquisition of 1 ~ 12 phases with selectable Real Time data, Graphing, Datalog and versatile export options
PPAcomm	Basic PC Control, Data storage, Print features
PPA Standby Power	Standby power measurements and reporting to IEC62301
PPASoft PC software	LabView based software, PC Control, Data storage and Print
IECSOft	IEC61000 Testing Software

Connection and extension port accessories (Optional)	
Type	Specification
Breakout box	Simple analyzer connection between source and DUT
PCIS	10Arms 300Apk rated Phase Controlled Inrush Switch
GPIB Communication Cable	GPIB Communication Cable Option (Port Fitted as standard on PPA5500)

Carry cases (Optional)	
Type	Specification
Soft carrying case	Black nylon with shoulder strap
Hard flight case	Hard case with moulded lining suitable for shipping



Breakout Box

Rack Mount Kit (Optional)	
Type	Specification
Rack Mount brackets	PPA26/5500 19in rack mount brackets (model specific)
Rack Mount panel	PPA2500 19in rack fascia panel

Interface (Optional)	
Type	Specification
PPA-LAN interface	Option L - LAN Interface - (Standard on 55 series)
PPA-GPIB interface	Option G - GPIB(IEEE488)Interface - (Standard on 55 series)

PPA Series Hard Carrying Case



PPA500/1500 MODELS

For more details see separate brochure

Phases	Model	Specification
1 Ph	PPA1510/510*	DC, 10mHz~1MHz 100mApk~300Apk (20Arms)
2 Ph	PPA1520/520*	
3 Ph	PPA1530/530*	
1 Ph	PPA1510/510-HC*	DC, 10mHz~1MHz 300mApk~1000Apk (30Arms)
2 Ph	PPA1520/520-HC*	
3 Ph	PPA1530/530-HC*	

*PPA500 DC, 10mHz~500kHz



PPA1500 3 Phase model

ACCESSORIES

High Performance Voltage Attenuating Probes			
Model	Voltage Range	Frequency Range	Details
TT-HV250	2500Vpk	300MHz	High Voltage Probe (Passive) 2.5kVpk 100:1
TTV-HVP	1500Vpk	50MHz	High Voltage Probe (Passive) 15kVpk 1000:1
ATT10	30Vpk	30MHz	10:1 Voltage Attenuator Box (For use in conjunction with HV Probes when output voltage of probe is >3Vpk, BNC Input/BNC Output)
ATT20	60Vpk	30MHz	20:1 Voltage Attenuator Box (For use in conjunction with HV Probes when output voltage of probe is >3Vpk, BNC Input/BNC Output)
ULCP	3000Vpk	2MHz	1000:1 Ultra Low Capacitance Probe (Active), For use in applications such as Ballast Testing (<1pF Capacitance)



TT-HV250 2.5kVpk Probes



TTV-HVP 15kVpk Probes



ATT10



ULCP

High Performance External Current Measurement Options					
Model Number	Measuring Range	Frequency Range	Basic Accuracy	Phase Accuracy	Details
HF003	3Arms - 30Apk	DC - 2MHz	470mΩ (±0.1%)	0.0001° / kHz	3Arms External Current Shunt, BNC Output (Use with PPA External Input)
HF006	6Arms - 60Apk	DC - 2MHz	100mΩ (±0.1%)	0.001° / kHz	6Arms External Current Shunt, BNC Output (Use with PPA External Input)
HF020	20Arms - 200Apk	DC - 2MHz	10mΩ (±0.1%)	0.01° / kHz	20Arms External Current Shunt, BNC Output (Use with PPA External Input)
HF100	100Arms - 1000Apk	DC - 2MHz	1mΩ (±0.1%)	0.05° / kHz	100Arms External Current Shunt, BNC Output (Use with PPA External Input)
HF200	200Arms - 2000Apk	DC - 2MHz	0.5mΩ (±0.1%)	0.1° / kHz	200Arms External Current Shunt, BNC Output (Use with PPA External Input)
HF500	500Arms - 5000Apk	DC - 2MHz	0.2mΩ (±0.1%)	0.1° / kHz	500Arms External Current Shunt, BNC Output (Use with PPA External Input)



External Shunt HF-003



External Shunt HF-100



External Shunt HF-200



External Shunt HF-500

Probe/Current Clamp Transformer: AC							
Model Number	Measuring range	Frequency range	Accuracy	Details	Clamp diameter	Category	
M3 UB 50A-1V	100mA ~ 50A	40Hz ~ 5kHz	1%	100mA to 50A AC Current Clamp	15mm×17mm	600V CATIII	
M3 U 100A-1V	1A ~ 100A	40Hz ~ 5kHz	1%	1A to 100A AC Current Clamp	15mm×17mm	600V CATIII	
S UE 200A-1V	1A ~ 200A	40Hz ~ 5kHz	1%	1 A to 200A AC Current Clamp	50mm ø	600V CATIII	
S UE 250 500 1000-1V	1A ~ 250A/500A/1000A	40Hz ~ 5kHz	1% (250A) 0.5% (500+1000A)	1 A to 250/500/1000A AC Current Clamp	50mm ø	600V CATIII	
US UE 1000A-1V	1A ~ 1000A	40Hz ~ 5kHz	1%	1A to 1000A AC Current Clamp	43mm ø	600V CATIII	
SM UE 1000A-1V	0.5A ~ 1000A (1% > 100A)	15Hz ~ 15kHz	1%	0.5A to 1000A AC Current Clamp	54mm ø	600V CATIII	
SM UB 1000A-1V	0.5A ~ 1000A (0.5% > 10A)	15Hz ~ 15kHz	0.5%	0.5A to 1000A AC Current Clamp	54mm ø	600V CATIII	
P32 UE 1000A-1V	5A ~ 1000A	40Hz ~ 5kHz	1%	5 A to 1000A AC Current Clamp	83mm ø (125mm×47mm or 100mm×58mm)	600V CATIII	
P32 UE 3000A-1V	5A ~ 3000A	40Hz ~ 5kHz	1%	5 A to 3000A AC Current Clamp	83mm ø	600V CATIII	



Current Clamp M3-UB 50A-1V



Current Clamp S-UE 200A-1V

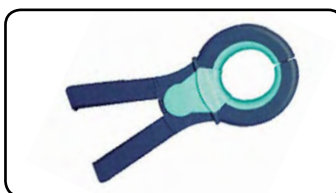

Current Clamp SM-UB 1000A-1V



Current Clamp P32-UE 1000A-1V

Probe / Current Clamp (Hall effect): AC + DC						
Model number	Measuring range	Frequency range	Accuracy	Details	Clamp diameter	Category
SC 3C 100A-1V	1A ~ 100A	DC ~ 5kHz	2%	1A to 100A AC+DC Current Clamp	50mm ϕ	600V CATIII
SC 3C 1000A-1V	1A ~ 1000A	DC ~ 2kHz	1%	1A to 1000A AC+DC Current Clamp	59mm ϕ	600V CATIII
P20 3C 2000A-2V	40A ~ 1000/2000A	DC ~ 2kHz	1%	40A to 2000A AC+DC Current Clamp	83mm ϕ	600V CATIII
P40 3C 4000A-2V	40A ~ 2000/4000A	DC ~ 2kHz	1.5%	40A to 4000A AC+DC Current Clamp	83mm ϕ	600V CATIII
P50 3C 5000A-2V	50A ~ 1000/5000A	DC ~ 2kHz	1.5%	50A to 5000A AC+DC Current Clamp	83mm ϕ	600V CATIII



Current Clamp SC 3C 100A-1V



Current Clamp SC 3C 1000A-1V



Current Clamp P20 3C 2000A-2V

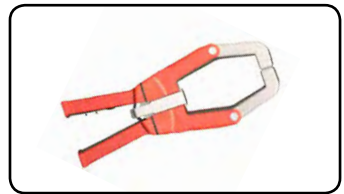

Current Clamp P50 3C 5000A-2V

Rogowski Current Transducer: AC / Zero Flux Current Transducer: AC+DC						
Model number	Measuring range	Frequency range	Accuracy	Details	Coil/Through Hole Circumference	Category
WR5000 Rogowski	1A ~ 5000A	1Hz ~ 1MHz	0.05%	1A to 5000A AC Rogowski Coil	600mm	600V CATIII
WR10000 Rogowski	1A ~ 10000A	1Hz ~ 1MHz	0.05%	1A to 5000A AC Rogowski Coil	600mm	600V CATIII
Zero Flux Current Transducer	0A ~ 200A	DC ~ 250kHz	0.01%	200A Zero Flux Current Transducer	27.6mm	600V CATIII
Zero Flux Current Transducer	0A ~ 600A	DC ~ 250kHz	0.01%	600A Zero Flux Current Transducer	27.6mm	600V CATIII



WR5000 Rogowski Coil



Danisense DS600

PPA5500 SERIES MODELS

Phases	Model	Specification
1 Ph	PPA5510-LC	DC, 10mHz ~ 2MHz 3mApk ~ 30Apk (10Arms)
2 Ph	PPA5520-LC	
3 Ph	PPA5530-LC	
4 Ph	PPA5540-LC	
5 Ph	PPA5550-LC	
6 Ph	PPA5560-LC	

Phases	Model	Specification
1 Ph	PPA5510	DC, 10mHz ~ 2MHz 30mApk ~ 300Apk (30Arms)
2 Ph	PPA5520	
3 Ph	PPA5530	
4 Ph	PPA5540	
5 Ph	PPA5550	
6 Ph	PPA5560	

Touchproof 50A screw connectors used on PPA5500-HC versions

Phases	Model	Specification
1 Ph	PPA5510-HC	DC, 10mHz ~ 1MHz 100mApk ~ 1000Apk (50Arms)
2 Ph	PPA5520-HC	
3 Ph	PPA5530-HC	
4 Ph	PPA5540-HC	
5 Ph	PPA5550-HC	
6 Ph	PPA5560-HC	

PPA4500 SERIES MODELS

Phases	Model	Specification
1 Ph	PPA4510-LC	DC, 10mHz ~ 2MHz 10mApk ~ 30Apk (10Arms)
2 Ph	PPA4520-LC	
3 Ph	PPA4530-LC	
4 Ph	PPA4540-LC	
5 Ph	PPA4550-LC	
6 Ph	PPA4560-LC	

Phases	Model	Specification
1 Ph	PPA4510	DC, 10mHz ~ 2MHz 100mApk ~ 300Apk (30Arms)
2 Ph	PPA4520	
3 Ph	PPA4530	
4 Ph	PPA4540	
5 Ph	PPA4550	
6 Ph	PPA4560	

Touchproof 50A screw connectors used on PPA4500-HC versions

Phases	Model	Specification
1 Ph	PPA4510-HC	DC, 10mHz ~ 1MHz 300mApk ~ 1000Apk (50Arms)
2 Ph	PPA4520-HC	
3 Ph	PPA4530-HC	
4 Ph	PPA4540-HC	
5 Ph	PPA4550-HC	
6 Ph	PPA4560-HC	



PPA5500 3 Phase model

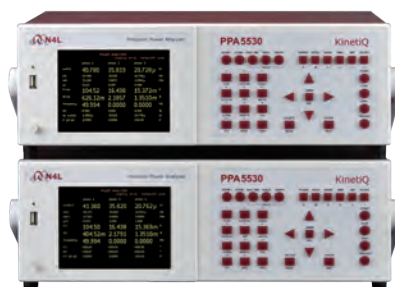

PPA5500 units in Master/Slave mode, synchronised for 4-6 Phase measurements

PRODUCT COMPARISON

	PPA500	PPA1500	PPA4500	PPA5500
Basic Accuracy				
V, A rdg error	0.05%	0.05%	0.03%	0.01%
Power rdg error	0.10%	0.10%	0.04%	0.03%
Phase Options				
Internal	1 ~ 3	1 ~ 3	1 ~ 3	1 ~ 3
Master/Slave operation	—	—	4 ~ 6	4 ~ 6
Bandwidth				
20 & 30A Shunt	DC ~ 500kHz	DC ~ 1MHz	—	—
10 & 30A Shunt	—	—	DC ~ 2MHz	DC ~ 2MHz
50A Shunt	—	—	DC ~ 1MHz	DC ~ 1MHz
Voltage Input				
Max input voltage	2500Vpk	2500Vpk	3000Vpk	3000Vpk
No. of ranges	8	8	8	9
Direct Current Input				
10Arms model	—	—	○	○
20Arms model	○	○	—	—
30Arms model	○	○	○	○
50Arms model	—	—	○	○
No. of ranges	8	8	8	9
Features				
Scope and Graph Modes	—	○	○	○
USB Memory port	○	○	○	○
LAN Port	○	○	○	○
GPIB Port	—	—	○	○
RS232 Port	○	○	○	○
Real time clock	○	○	○	○
19in Rack mount option	○	○	○	○
Torque and Speed	—	—	○	○
IEC61000 Mode	—	—	—	○
PWM Motor Drive Mode	—	○	○	○
Oscilloscope	—	○	○	○
Transformer Mode	—	—	○	○
PWM Filter Options	—	2	7	7
Speed/Harmonics/Sec	300/sec	300/sec	600/sec	1800/sec
Internal Datalogging	4 Parameters	4 Parameters	16 Parameters	16 Parameters
Datalog Records	16000	16000	16000	10M
ABD0100.1.8 Mode	—	—	—	○
Internal Memory	192kB	192kB	200MB	1GB
Harmonics	50	50	100	417
Minimum Window Size	10ms	2ms	10ms	2ms
Dimensions - Excl. Feet H x W x D (mm)	92 x 215 x 312	92 x 215 x 312	130 x 400 x 315	130 x 400 x 315
Weight	3.3 - 4kg	3.3 - 4kg	5.4 - 6kg	5.4 - 6kg

— Not Applicable ○ Option ● Standard

All specifications at 23°C ± 5°C. These specifications are quoted in good faith but Newtons4th Ltd reserves the right to amend any specification at any time without notice.

The N4L product range also includes Frequency Response and Impedance Analyzers, Selective Level Meters and Laboratory Power Amplifiers

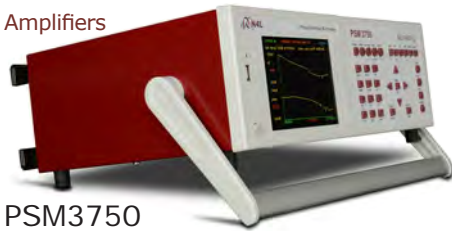

PSM3750
10μHz ~ 50MHz



PSM17xx
10μHz ~ 35MHz

Applications



- Power supply phase margin and gain margin (FRA)
- Inductance, Capacitance and Resistance (LCR)
- Analysis of mechanical vibration (HARM)
- Phase Angle Voltmeter (PAV)

Contact your local N4L Distributor for further details

Newtons4th

Newtons4th Ltd (abbreviated to N4L) was established in 1997 to design, manufacture and support innovative electronic equipment to a world-wide market, specialising in sophisticated test equipment particularly related to phase measurement. The company was founded on the principle of using the latest technology and sophisticated analysis techniques in order to provide our customers with accurate, easy to use instruments at a lower price than has been traditionally associated with these types of measurements. Flexibility in our products and an attitude to providing the solutions that our customers really want has allowed us to develop many innovative functions in our ever increasing product range.



Newtons4th Ltd are ISO9001 registered, the internationally recognised standard for the quality management of businesses



In recognition of the technical innovation and commercial success of the PPA series, N4L received the "Innovation 2010" Queen's award for enterprise

USED4TEST

Телефон: +7 (499) 685-7744

used@used4test.ru

www.used4test.ru